



PRODUCT BROCHURE

Air Conditioners, Fans, Filters & Heaters

Thermal Control - Cooling

AC

Air Conditioners

350W to 4kW | Indoor & Outdoor



IP Enclosures air conditioners are designed for the cooling needs of electrical cabinets, optimised for door or side-panel mounting and have been designed for high efficiency and low maintenance. They are made in Italy and are SAA approved and certified for use in Australia.

350W Wall Mounted Air Conditioner		INDOOR	OUTDOOR
Part Number	SKU	IP-ACIWM035.001	IP-ACOWM035
Power supply	V/Hz	230V/ 1ph/50-60	
Dimensions HxWxD	mm	430x280x170	
Cooling capacity A35A35	W	350/370	
Cooling capacity A35A50	W	200/220	
Max current	A	1.8/1.9	
Delayed fuse	A	4	
Absorbed electric power A35A35	W	260/270	
Absorbed electric power A35A50	W	280/300	
850W Wall Mounted Air Conditioner		INDOOR	OUTDOOR
Part Number	SKU	IP-ACIWM085.001	IP-ACOWM085
Power supply	V/Hz	230V/ 1ph/50-60	
Dimensions HxWxD	mm	635x305x210	
Cooling capacity A35A35	W	850/900	
Cooling capacity A35A50	W	625/650	
Max current	A	2.65/2.75	
Delayed fuse	A	6	
Absorbed electric power A35A35	W	450/470	
Absorbed electric power A35A50	W	530/560	
1450W Wall Mounted Air Conditioner		INDOOR	OUTDOOR
Part Number	SKU	IP-ACIWM145.001	IP-ACOWM145
Power supply	V/Hz	230V/ 1ph/50-60	
Dimensions HxWxD	mm	800x400x240	
Cooling capacity A35A35	W	1450/1500	
Cooling capacity A35A50	W	1150/1200	
Max current	A	3.7/4.2	
Delayed fuse	A	6	
Absorbed electric power A35A35	W	650/700	
Absorbed electric power A35A50	W	770/850	
2000W Wall Mounted Air Conditioner		INDOOR	OUTDOOR
Part Number	SKU	IP-ACIWM200.001	IP-ACOWM200
Power supply	V/Hz	230V/ 1ph/50-60	
Dimensions HxWxD	mm	1000x400x240	
Cooling capacity A35A35	W	2000/2100	
Cooling capacity A35A50	W	1200/1250	
Max current	A	6.6/6.9	
Delayed fuse	A	10	
Absorbed electric power A35A35	W	1060/1100	
Absorbed electric power A35A50	W	1240/1300	
3000W Wall Mounted Air Conditioner		INDOOR	OUTDOOR
Part Number	SKU	IP-ACIWM300.001	IP-ACOWM300
Power supply	V/Hz	400V/3ph/50 - 460V/3ph/60	
Dimensions HxWxD	mm	1500x400x255	
Cooling capacity A35A35	W	2800/2950	
Cooling capacity A35A50	W	2150/2330	
Max current	A	2.2/2.6	
Delayed fuse	A	16	
Absorbed electric power A35A35	W	2090/2200	
Absorbed electric power A35A50	W	2400/2550	
4000W Wall Mounted Air Conditioner		INDOOR	OUTDOOR
Part Number	SKU	IP-ACIWM400.001	IP-ACOWM400
Power supply	V/Hz	400V/3ph/50 - 460V/3ph/60	
Dimensions HxWxD	mm	1500x400x255	
Cooling capacity A35A35	W	3800/3980	
Cooling capacity A35A50	W	2800/3160	
Max current	A	2.7/3.0	
Delayed fuse	A	16	
Absorbed electric power A35A35	W	2200/2320	
Absorbed electric power A35A50	W	2600/2750	

Note: Air-Conditioner Flow Diverter & Assembly are also available upon request.

Thermal Control - Cooling

AC

Stainless Steel Grade 304 | Air Conditioners

350W to 4kW | Outdoor



IP Enclosures stainless steel air conditioners are designed for the cooling needs of electrical cabinets, optimised for door or side-panel mounting and have been designed for high efficiency and low maintenance. They are made in Italy and are SAA approved and certified for use in Australia.

350W Wall Mounted Air Conditioner		OUTDOOR
Part Number	SKU	IP-ACOWM035.OX
Power supply	V/Hz	230V/ 1ph/ 50-60
Dimensions HxWxD	mm	430x280x170
Cooling capacity A35A35	W	350/370
Cooling capacity A35A50	W	200/220
Max current	A	1.8/1.9
Delayed fuse	A	4
Absorbed electric power A35A35	W	260/270
Absorbed electric power A35A50	W	280/300
850W Wall Mounted Air Conditioner		OUTDOOR
Part Number	SKU	IP-ACOWM085.OX
Power supply	V/Hz	230V/ 1ph/ 50-60
Dimensions HxWxD	mm	635x305x210
Cooling capacity A35A35	W	850/900
Cooling capacity A35A50	W	625/650
Max current	A	2.65/2.75
Delayed fuse	A	6
Absorbed electric power A35A35	W	450/470
Absorbed electric power A35A50	W	530/560
1450W Wall Mounted Air Conditioner		OUTDOOR
Part Number	SKU	IP-ACOWM145.OX
Power supply	V/Hz	230V/ 1ph/ 50-60
Dimensions HxWxD	mm	800x400x240
Cooling capacity A35A35	W	1450/ 1500
Cooling capacity A35A50	W	1150/ 1200
Max current	A	3.7/ 4.2
Delayed fuse	A	6
Absorbed electric power A35A35	W	650/ 700
Absorbed electric power A35A50	W	770/ 850
2000W Wall Mounted Air Conditioner		OUTDOOR
Part Number	SKU	IP-ACOWM200.OX
Power supply	V/Hz	230V/ 1ph/ 50-60
Dimensions HxWxD	mm	1000x400x240
Cooling capacity A35A35	W	2000/2100
Cooling capacity A35A50	W	1200/ 1250
Max current	A	6.6/6.9
Delayed fuse	A	10
Absorbed electric power A35A35	W	1060/ 1100
Absorbed electric power A35A50	W	1240/ 1300
3000W Wall Mounted Air Conditioner		OUTDOOR
Part Number	SKU	IP-ACOWM300.OX
Power supply	V/Hz	400V/3ph/50 - 460V/3ph/60
Dimensions HxWxD	mm	1500x400x255
Cooling capacity A35A35	W	2800/2950
Cooling capacity A35A50	W	2150/2330
Max current	A	2.2/2.6
Delayed fuse	A	16
Absorbed electric power A35A35	W	2090/2200
Absorbed electric power A35A50	W	2400/2550
4000W Wall Mounted Air Conditioner		OUTDOOR
Part Number	SKU	IP-ACOWM400.OX
Power supply	V/Hz	400V/3ph/50 - 460V/3ph/60
Dimensions HxWxD	mm	1500x400x255
Cooling capacity A35A35	W	3800/3980
Cooling capacity A35A50	W	2800/3160
Max current	A	2.7/3.0
Delayed fuse	A	16
Absorbed electric power A35A35	W	2200/2320
Absorbed electric power A35A50	W	2600/2750

Note: Air-Conditioner Flow Diverter & Assembly are also available upon request.

Thermal Control - Ventilation

IP-V

Filter Vents & Fans

12VDC to 230VAC | 26m³/h to 700m³/h | IP54 (IP55 Optional)



IP Enclosures range of filter fans and vents feature a modern Italian grille design with minimal external projection. The front-opening grille allows filters to be easily maintained from the outside of the enclosure.

Features & Specifications

IP Enclosures provide a wide range of ventilation products for electrical enclosures. The front-opening grille allows filters to be easily maintained from the outside of the enclosure. All molded parts are made of highly resistant and self-extinguishing ABS. IP Enclosures ventilation products are manufactured to the highest quality in Italy.

Protection: IP54 (or IP55 if used with High Efficiency Filter Mat IP-VFXX or Vent Hood)

Conformity:  

Material: ABS UL94V-0 color RAL7035 (Optional Colour Black)

Flow Direction: Reversible

FEATURES

Modern Design: A positive visual impact is provided by the modern grille design and minimal external projection. All molded parts are made of highly resistant and self-extinguishing ABS, UL94 VO grade. The standard color is RAL7035.

Easy Maintenance: Filter mats can be easily maintained from outside of the enclosure due to the front-opening grille. Replacement of soiled filter mats takes only a few seconds without the use of tools.

Wide Range of Air Flow Ratings: 26m³/h to 700m³/h

Optimal Enclosure Protection: The special configuration of the grille, foam seal gasket and filter mat ensures an IP54 protection of the enclosure.

Quick Electrical Connection: Fitted with spring terminals for faster and safer wiring. Default terminal position is above the fan but can be easily changed to bottom of fan to suit wiring needs without tools.

Reversible Fan: Default air flow direction is from outside to inside of the enclosure. If required, air flow can be reversed due to quick release fan lock system without the use of tools.

Fast Installation: Installation is fast due to the simple square cutout on the enclosure and the snap-in fixing system. No fasteners are required.

Vent Hoods: To obtain IP55 protection, use in conjunction with IP Enclosures vent hoods. Hinged vent hoods are available to provide operator access to easily maintain filters from the outside of the enclosure.



Easy Maintenance due to Front Opening Grille



Step 1: Open Grille



Step 2: Remove Filter



Step 3: Insert Filter



Step 4: Close Grille

114mm x 114mm 26m3/hr		Vent	230V Fan	115V Fan	12VDC Fan	24VDC Fan
Part Number	SKU	IP-V1000	IP-V1100	IP-V1101	IP-V1112	IP-V1124
Air flow rate (free blow)	m3/h	-	26 (30)		26	
Air flow rate with exit filter	m3/h	-	15 (18)		15	
Power supply	V/Hz	-	230 / 50-60	115 / 50-60	12DC	24DC
Dimensions HxWxD	mm	114x114x27	114x114x73		114x114x73	
Power consumption	W	-	13 (12)		3	4
Current consumption	A	-	0.10 (0.08)	0.14 (0.12)	0.25	0.16
Overcurrent protection	-	-	impedance			
Electrical connection	-	-	3-poles spring terminals*		2-poles spring terminals*	
Duty cycle	-	-	100%			
Operating temperature	-	-	-10 / +70 (+14/+158)			
Protection degree I Class	-	IP54	IP54 / Class I			
Noise level	dB(A)	-	30 (35)		35	
Flow direction	-	-	reversible, default factory setting outside-in			
Bearing	-	-	ball			
Filter mat EN779	-	G2	G2			
Cut-out Dimensions	mm	92x92	92x92			
Material	-	-	ABS UL94V-0 color RAL7035			
Replacement Filter Mat	-	IP-VF1	IP-VF1	-	-	-
High Efficiency Filter Mat (G3)	-	IP-VF1X	IP-VF1X	-	-	-

150mm x 150mm 58m3/hr		Vent	230V Fan	115V Fan	24VDC Fan	48VDC Fan
Part Number	SKU	IP-V2000*	IP-V2200*	IP-V2201	IP-V2224	IP-V2248
Air flow rate (free blow)	m3/h	-	58(64)		58	
Air flow rate with exit filter	m3/h	-	43(48)		43	
Power supply	V/Hz	-	230 / 50-60	115 / 50-60	24DC	48DC
Dimensions HxWxD	mm	150x150x37	150x150x86			
Power consumption	W	-	22 (21)		9	13
Current consumption	A	-	0.14 (0.12)	0.26 (0.24)	0.37	0.27
Overcurrent protection	-	-	impedance			
Electrical connection	-	-	3-poles spring terminals*		2-poles spring terminals*	
Duty cycle	-	-	100%			
Operating temperature	°C (°F)	-	-10 / +70 (+14/+158)			
Protection degree I Class	-	IP54	IP54 / Class I			
Protection degree I Class	dB(A)	-	43 (49)		45	
Flow direction	-	-	reversible, default factory setting outside-in			
Bearing	-	-	ball			
Filter mat EN779	-	G3	G3			
Cut-out Dimensions	mm	124x124	124x124			
Material	-	-	ABS UL94V-0 color RAL7035*			
Replacement Filter Mat	-	IP-VF2	IP-VF2	-	-	-
High Efficiency Filter Mat (G4)	-	IP-VF2X	IP-VF2X	-	-	-

*Available in Black IP-V2000-BLK; IP-V2200-BLK

204mm x 204mm 115m3/hr		Vent	230V Fan	115V Fan	24VDC Fan	48VDC Fan
Part Number	SKU	IP-V3000*	IP-V3200	IP-V3201	IP-V3224	IP-V3248
Air flow rate (free blow)	m3/h	-	115 (125)		115	
Air flow rate with exit filter	m3/h	-	84 (97)		84	
Power supply	V/Hz	-	230 50-60	115 / 50-60	24DC	48DC
Dimensions HxWxD	mm	204x204x37	204x204x104			
Power consumption	W	-	22 (21)		9	13
Current consumption	A	-	0.14 (0.12)	0.26 (0.24)	0.37	0.27
Overcurrent protection	-	-	impedance			
Electrical connection	-	-	3-poles spring terminals*		2-poles spring terminals*	
Duty cycle	-	-	100%			
Operating temperature	°C (°F)	-	-10 / +70 (+14/+158)			
Protection degree I Class	-	IP54	IP54 / Class I			
Protection degree I Class	dB(A)	-	43 (49)		45	
Flow direction	-	-	reversible, default factory setting outside-in			
Bearing	-	-	ball			
Filter mat EN779	-	G3	G3			
Cut-out Dimensions	mm	177x177	177x177			
Material	-	-	ABS UL94V-0 color RAL7035			
Replacement Filter Mat	-	IP-VF3	IP-VF3	-	-	-
High Efficiency Filter Mat (G4)	-	IP-VF3X	IP-VF3X	-	-	-

Note: Filter Vents and Fans are also available in Black colour upon request.

250mm x 250mm 125m3/hr		Vent	230V Fan	115V Fan	24VDC Fan	48VDC Fan
Part Number	SKU	IP-V3000*	IP-V3200	IP-V3201	IP-V3224	IP-V3248
Air flow rate (free blow)	m3/h	-	125 (135)		125	
Air flow rate with exit filter	m3/h	-	102(112)		102	
Power supply	V/Hz	-	230 50-60	115 / 50-60	24DC	48DC
Dimensions HxWxD	mm	250x250x38	250x250x107			
Power consumption	W	-	22 (21)		9	13
Current consumption	A	-	0.14 (0.12)	0.26 (0.24)	0.37	0.27
Overcurrent protection	-	-	impedance			
Electrical connection	-	-	3-poles spring terminals*		2-poles spring terminals*	
Duty cycle	-	-	100%			
Operating temperature	°C (°F)	-	-10 / +70 (+14/+158)			
Protection degree I Class	-	IP54	IP54 / Class I			
Protection degree I Class	dB(A)	-	43 (49)		45	
Flow direction	-	-	reversible, default factory setting outside-in			
Bearing	-	-	ball			
Filter mat EN779	-	G3	G3			
Cut-out Dimensions	mm	224x224	224x224			
Material	-	-	ABS UL94V-0 color RAL7035			
Replacement Filter Mat	-	IP-VF4	IP-VF4	-	-	-
High Efficiency Filter Mat (G4)	-	IP-VF4X	IP-VF4X	-	-	-

250mm x 250mm 255m3/hr to 410m3/hr		Vent	230V	115V	24VDC	48VDC	230V	115V	400V
Part Number	SKU	IP-V4000	IP-V4300	IP-V4301	IP-V4324	IP-V4348	IP-V4400	IP-V4401	IP-V4440
Air flow rate (free blow)	m3/h	-	255 (290)		25		410 (445)		
Air flow rate with exit filter	m3/h	-	202 (235)		202		280 (302)		
Power supply	V/Hz	-	230 50-60	115 / 50-60	24DC	48DC	230 / 50-60	115/50-60	400 / 50-60
Dimensions HxWxD	mm	250x250x38	250x250x107		250x250x136				
Power consumption	W	-	40 (38)		26	33	70 (90)		60 (70)
Current consumption	A	-	0.17 (0.16)	0.34 (0.32)	1.08	0.68	0.40 (0.38)	0.80 (0.76)	0.18 (0.15)
Overcurrent protection	-	-	thermal		impedance		thermal		
Electrical connection	-	-	3-poles spring terminals*		2-poles spring terminals*		3-poles spring terminals*		4-p st*
Duty cycle	-	-	100%						
Operating temperature	°C (°F)	-	-10 / +70 (+14/+158)						
Protection degree I Class	-	IP54	IP54 / Class I						
Protection degree I Class	dB(A)	-	53 (58)		61		65 (68)		
Flow direction	-	-	reversible, default factory setting outside-in						
Bearing	-	-	ball						
Filter mat EN779	-	G3	G3						
Cut-out Dimensions	mm	224x224	224x224						
Material	-	-	ABS UL94V-0 color RAL7035						
Replacement Filter Mat	-	IP-VF4	IP-VF4	-	-	-	-	-	-
High Efficiency Filter Mat (G4)	-	IP-VF4X	IP-VF4X	-	-	-	-	-	-

325mm x 325mm 550m3/hr to 700m3/hr		Vent	230V Fan	115V Fan	400V Fan	230V Fan	115V Fan
Part Number	SKU	IP-V5000	IP-V5400	IP-V5401	IP-V5440	IP-V5500	IP-V5501
Air flow rate (free blow)	m3/h	-	550 (620)		700 (770)		
Air flow rate with exit filter	m3/h	-	405 (450)		520 (575)		
Power supply	V/Hz	-	230 50-60	115 / 50-60	400 / 50-60	230 / 50-60	115 / 50-60
Dimensions HxWxD	mm	325x325x42	325x325x140		325x325x154		
Power consumption	W	-	70 (90)		60 (70)	130 (180)	
Current consumption	A	-	0.40 (0.38)	0.80 (0.76)	0.18 (0.15)	0.55 (0.81)	1.10 (1.62)
Overcurrent protection	-	-	thermal				
Electrical connection	-	-	3-poles spring terminals*		4-p st*	3-poles spring terminals*	
Duty cycle	-	-	100%				
Operating temperature	°C (°F)	-	-10 / +70 (+14/+158)				
Protection degree I Class	-	IP54	IP54 / Class I				
Protection degree I Class	dB(A)	-	65 (68)		72 (73)		
Flow direction	-	-	reversible, default factory setting outside-in				
Bearing	-	-	ball				
Filter mat EN779	-	G3	G3				
Cut-out Dimensions	mm	291x291	291x291				
Material	-	-	ABS UL94V-0 color RAL7035				
Replacement Filter Mat	-	IP-VF5	IP-VF5	-	-	IP-VF5	-
High Efficiency Filter Mat (G4)	-	IP-VF5X	IP-VF5X	-	-	IP-VF5X	-

Note: Filter Vents and Fans are also available in Black colour upon request.

Thermal Control - Ventilation

Roof Vents & Roof Fans

RV/RFV

230VAC | 600m³/h to 1500m³/h | IP44, IP54



IP Enclosures provide a wide range of roof mounted ventilation products for electrical cabinets.

Features & Specifications

RV/RFV

IP Enclosures provide a wide range of ventilation products for electrical enclosures. All molded parts are made of highly resistant and self-extinguishing ABS. IP Enclosures ventilation products are manufactured to the highest quality in Italy.

Protection: IP44, IP54

Conformity:  

Material: ABS UL94V-0 color RAL7035 | Steel Color RAL7035

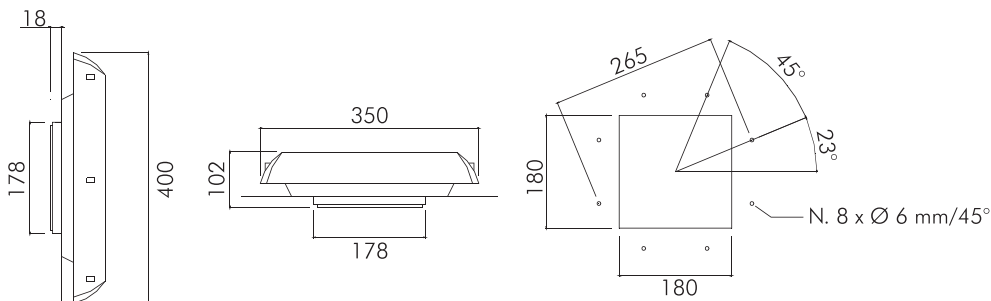

		Roof Vent	600m3 Fan	860m3 Fan	1000m3 Fan	Roof Vent	1500m3 Fan
Features	Unit	IP-RV1	IP-RFV1	IP-RFV2	IP-RFV3	IP-RV4	IP-RFV4
Air flow rate (free blow)	m³/h	-	600/(625)	860/(950)	1000/(1050)	-	1500/(1550)
Flow rate with filter fan	m³/h	-	430/(450)	580/(640)	700/(720)	-	900/(950)
Power supply	V/Hz	-	230-50/60	230-50/60	230-50/60	-	230-50/60
Dimensions HxWxD	mm	400x350x102				540x390x150	540x390x128
Power consumption	W	-	70/(90)	85/(115)	120/(170)	-	160/(215)
Current consumption	A	-	0.32/(0.40)	0.43/(0.50)	0.50/(0.75)	-	0.70/(0.98)
Overcurrent protection	-	-	thermal			-	thermal
Electric connection	-	-	4-pole terminal 2.5 mm²			-	4-pole terminal 2.5 mm²
Duty cycle	-	-	100%			-	100%
Operating temperature	°C(°F)	-10/+70 (+14/+158)				-20/+50 (-4/+22)	-10/+70 (+14/+158)
Protection degree enclosure side	-	IP44				IP54	IP44
Protection class	-	-	Class I			-	Class I
Noise level	dB(A)	-	64(65)	72(73)	72(73)	-	74(75)
Flow direction	-	-	inside-out			-	inside-out
Bearing	-	-	ball			-	ball
Service life (at 40°C)	hr	-	50.000			-	50.000
Material	-	ABS UL94V-0 Color RAL7035				Steel Color RAL7035	
Gasket	-	Self-Adhesive				PVC	
Weight (with packaging)	kg	2.30(2.50)	3.65(3.85)	4.00(4.20)	4.75(4.95)	5.2(5.5)	11.3(12.3)
Package dimensions	mm	410x360x130				550x400x140	
Mounting	-	Screws					
Conformity/ Certifications	-	CE					

Thermal Control - Heat Exchangers

Air/Air Heat Exchangers

HEX

IP Enclosures heat exchangers are designed for the cooling needs of electrical cabinets. By utilising the heat exchange between two separate air flows through an aluminium pack, air/air heat exchangers allow heat to be dissipated inside electrical panels. They are recommended if the outside air has a lower temperature value than the inside air, a low cooling capacity is required, if the ambient air is excessively oily or dusty, or if the outside air and humidity cannot enter the cabinet.

Features & Specifications

- Installation: internal/external
- Heat exchange core made of aluminium, to ensure high efficiency with compact dimensions
- Specific heat transmission 16-85 W/K

Features	Unit	IP-HEX16	IP-HEX35	IP-HEX50	IP-HEX80
Specific Heat Transmission	W/K	16	35	50	80
Power Supply	V / Ph / Hz	230 / 1 / 50-60	-	-	-
Current Consumption	A	0.46 / 0.58	0.46 / 0.58	0.46 / 0.58	0.72 / 0.96
Absorbed Fan Power	W/K	64	100 / 130	100 / 130	160 / 200
Side Cabinet Fan Flow (Free Blowing)	m ³ /hr	136	575	575	860
Internal Operating Temp	°C	-5 / +55	-	-	-
Ambient Temperature Limit	°C	-5 / +55	-	-	-
Internal Circuit Protection Degree	IP	IP54	IP55	IP55	IP55
Noise Level	dB (A)	58	76	76	76
Installation	-	Internal / External	-	-	-
Dimensions (H x W x D)	mm	410 x 204 x 109	780 x 254 x 90	780 x 312 x 90	1250 x 311 x 108
Weight	kg	4.6	7.5	9.5	20
Conformity	-	CE	-	-	-



Thermal Control - Controllers

Thermostats, Hygrostat & Fan Speed Controller

IP Enclosures thermal control products are manufactured to the highest quality in Italy and are suitable for use with IP Enclosures range of heating and cooling products.

Single Thermostats | NC/NO

		●	●	●	●	●	●
Contact function	-	NC	NC	NC	NO	NO	NO
Temperature setting range	°C	-10/+50	0/+60	+20/+80	-10/+50	0/+60	+20/+80
Precision	°C	±4					
Hysteresis	°C	7					
Max switching current	-						
250Vac resistive load (inductive load)	A	10 (1.6)					
125Vac resistive load (inductive load)	A	15 (2.5)					
Max. switching power in Vdc	W	30					
Temperature sensor type	-	Thermostatic bimetal					
Contact type	-	Snap action					
Contact resistance	mOhm	< 10					
Service life	cycles	> 100 000					
Electrical connections	-	2-pole terminal for 2.5 mm ² wire					
Casing	-	PA6, UL94 V0 self-extinguishing, light grey RAL 7035					
Protection degree EN60529	-	IP20					
Operating temperature	°C (°F)	-25/+80 (-13/+176)					
Storage temperature	°C (°F)	-45/+80 (-49/+176)					
Mounting	-	Clip for mounting on DIN rail 35 mm EN50022					
Installation position	-	Variable					
Conformity/Certifications	-	CE-UL _{CS}  us					
Dimensions HxWxD	mm	61x34x35					



Double Thermostats | NC/NO

		●	●	●	●	●	●
Contact function	-	NC	NO	NC	NO	NO	NO
Temperature setting range	°C	-10/+50	+20/+80	0/+60	0/+60	0/+60	0/+60
Precision	°C	±4					
Hysteresis	°C	7					
Max switching current	-						
250Vac resistive load (inductive load)	A	10 (1.6)					
125Vac resistive load (inductive load)	A	15 (2.5)					
Max. switching power in Vdc	W	30					
Temperature sensor type	-	Thermostatic bimetal					
Contact type	-	Snap action					
Contact resistance	mOhm	< 10					
Service life	cycles	> 100 000					
Electrical connections	-	2-pole terminal for 2.5 mm ² wire					
Casing	-	PA6, UL94 V0 self-extinguishing, light grey RAL 7035					
Protection degree EN60529	-	IP20					
Operating temperature	°C (°F)	-25/+80 (-13/+176)					
Storage temperature	°C (°F)	-45/+80 (-49/+176)					
Mounting	-	Clip for mounting on DIN rail 35 mm EN50022					
Installation position	-	Variable					
Conformity/Certifications	-	CE-UL _{CS}  us File n. E348803					
Dimensions HxWxD	mm	61x53x35					



Mechanical Hygrostat

Relative Humidity setting range	RH%	20-90
Relative Humidity Hysteresis	RH%	5 (max 10)
Precision	RH%	±4
Operating temperature	°C (°F)	-10/+50 (+14/+122)

Fan Speed Controller (Image not shown)

FEATURES	UNIT	IP-FSC1
Power supply	V/Hz	100-230/50-60
Temperature setting range	°C	+20 / +60
Fan speed setting range	%	0 - 100
Speed controller	-	partialization of wave
Input	-	NTC sensor
Max. output fan	-	300 W (100-230/50-60Hz)
Electrical connection	-	terminal for 2.5 mm ² wire
Optical signal	-	LED
Casing	-	PA6, UL94 V0 self-extinguishing, light grey RAL 7035
Protection degree EN60529	-	IP20



Thermal Control - Heating

Anti-Condensation Heaters

IP-H

Compact, Touch Shield & Fan-Assisted | 50W to 750W



Anti-condensation heaters are required to prevent failures or corrosion caused by low temperatures or high humidity. IP Enclosures heating products are manufactured to the highest quality in Italy.

Anti-Condensation Heaters for Electrical Enclosures

IP-H

IP Enclosures provide a range of heating products for electrical enclosures. Our range of heating products are manufactured to the highest quality in Italy.

Compact | 50W to 150W

FEATURES	UNIT	IP-H50	IP-H75	IP-H100	IP-H150
Heating Capacity*	W	50	75	100	150
Power supply	V	120-240V AC or DC			
24V Voltage Availability	V	IP-H50.24	IP-H100.24		
48V Voltage Availability	V	IP-H100.48			
Inrush current	A	3.5	4	5	9.5
Delayed fuse (advised)	A	4	6.3	8	10
Electrical connections	-	2 screw terminals for stranded or rigid wire 2.5 mm ²			
Protection Class	-	Class II			
Protection degree EN60529	-	IP20			
Operating temperature	°C (°F)	-45/+70 (-49/+158)			
Storage temperature	°C (°F)	-45/+80 (-49/+176)			
Dimensions HxWxD	mm	100x40x40	140x59x61		220x59x61
Weight (with packaging)	kg		0.34 (0.38)		0.57 (0.62)
Conformity/Certifications	-	CE- UL 			
VERSIONS					
with Integrated fixed thermostat NC 5°C		IP-H50.001	IP-H75.001	IP-H100.001	IP-H150.001



Touch Shield | 25W to 150W

FEATURES	UNIT	IP-TSH25	IP-TSH50	IP-TSH75	IP-TSH100	IP-TSH150
Heating Capacity	W	25	50	75	100	150
Power supply	V	120-240V AC or DC				
Inrush current	A	2.5	3.5	4	5	9.5
Delayed fuse (advised)	A	4	4	6.3	8	10
Electrical connections	-	2 screw terminals for stranded or rigid wire 2.5 mm ²				
Protection class	-	Class II				
Protection degree EN60529	-	IP20				
Operating temperature	°C (°F)	-45/+70 (-49/+158)				
Storage temperature	°C (°F)	-45/+80 (-49/+176)				
Dimensions HxWxD	mm	125x41x41	140x63x70			220x63x70
Weight (with packaging)	kg	0.16 (0.19)	0.42 (0.46)			0.66 (0.72)
Conformity/Certifications	-	CE-UL 				
VERSIONS						
with Integrated fixed thermostat NC 5°C		IP-TSH25.001	IP-TSH50.001	IP-TSH75.001	IP-TSH100.001	IP-TSH150.001



Fan Assisted | 250W to 750W

FEATURES	UNIT	IP-FH250	IP-FH251	IP-FH400	IP-FH401	IP-FH500	IP-FH501	IP-FH750	IP-FH751	
Heating Capacity	W	250	250	400	400	500	500	750	750	
Power Supply	V/Hz	230/50-60	115/50-60	230/50-60	115/50-60	230/50-60	115/50-60	230/50-60	115/50-60	
Max. current	A	1.2	2.4	1.9	3.8	2.4	4.8	3.6	7.2	
Electrical connections	-	3 screw terminals for stranded or rigid wire 2.5 mm ²								
Protection class	-	Class I, earthed								
Protection degree EN60529	-	IP20								
Operating temperature	°C (°F)	-25/+70 (-13/+158)								
Storage temperature	°C (°F)	-45/+80 (-49/+176)								
Air flow rate	m ³ /h	35 (free flow)						44 (free flow)		
Signalling	-	Green LED power ON								
Dimensions HxWxD	mm	135x112x82	135x112x82	165x112x82	165x112x82	165x112x82	165x112x82	225x112x82	225x112x82	
Weight (with packaging)	kg	0.88(0.94)	0.88(0.94)	0.97(1.04)	0.97(1.04)	0.97(1.04)	0.97(1.04)	1.35(1.42)	1.35(1.42)	
Conformity/Certifications	-	CE-UL 								



Fan Assisted (Small Footprint) | 150W to 400W

FEATURES	UNIT	IP-TMX150	IP-TMX250	IP-TMX300	IP-TMX400
Heating Capacity	W	150	250	300	400
Power Supply	V/Hz	230/50-60			
Max. current	A	-	-	-	-
Delayed fuse (advised)	A	6.3	6.3	6.3	6.3
Electrical connections	-	Spring terminals			
Protection class	-	Class II			
Protection degree EN60529	-	IP20			
Operating temperature	°C (°F)	-40/+70 (-40/+158)			
Storage temperature	°C (°F)	-40/+70 (-40/+158)			
Air flow rate	m ³ /h	30 (free flow)			
Signalling	-	-			
Dimensions HxWxD	mm	88x66x97	88x66x97	88x66x97	88x66x97
Weight (with packaging)	kg	0.35	0.35	0.35	0.35
Conformity/Certifications	-	CE-UL			



Accessories

Louvre Vents, Vent Hoods & Sun Shields



IP Enclosures vent hoods assist to protect internal components by increasing the protection of fans and vents up to IP56. Hinged vent hoods are also available to enable easy access to fans and filters for filter maintenance without the need to open the enclosure.

Louvre Vents

STEEL



Part Number	Size	Part Number Suffix
Standard	H x W (mm)	Optional Colours
IP-PSLV10075	100 x 75	-T33 -BLK -OR -RED
IP-PSLV130130	130 x 130	-T33 -BLK -OR -RED
IP-PSLV250250	250 x 250	-T33 -BLK -OR -RED

STAINLESS STEEL

Part Number	Size
Standard	H x W (mm)
IP-SSLV10075	100 x 75
IP-SSLV130130	130 x 130
IP-SSLV250250	250 x 250



Vent Hoods

STEEL



STAINLESS STEEL



Part Number		Part Number		To Suit Fan/Vent	Size	Part Number Suffix
Standard	Hinged	Standard	Hinged	Size	H x W x D (mm)	Optional Colours (Steel)
IP-PSVH2517	IP-PSVH2517-H	IP-SSVH2517	IP-SSVH2517-H	IP-V1XXX	250 x 175 x 50	-T33 -BLK -OR -RED
IP-PSVH3020	IP-PSVH3020-H	IP-SSVH3020	IP-SSVH3020-H	IP-V1XXX	300 x 200 x 50	-T33 -BLK -OR -RED
IP-PSVH3222	IP-PSVH3222-H	IP-SSVH3222	IP-SSVH3222-H	Up to IPV2XXX	320 x 220 x 50	-T34 -BLK -OR -RED
IP-PSVH4030	IP-PSVH4030-H	IP-SSVH4030	IP-SSVH4030-H	Up to IPV3XXX	400 x 300 x 50	-T35 -BLK -OR -RED
IP-PSVH4737	IP-PSVH4737-H	IP-SSVH4737	IP-SSVH4737-H	Up to IPV4XXX	475 x 375 x 75	-T33 -BLK -OR -RED
IP-PSVH5040	IP-PSVH5040-H	IP-SSVH5040	IP-SSVH5040-H	Up to IPV5XXX	500 x 400 x 75	-T33 -BLK -OR -RED

IP Rating: IP55. Item marked with " * " is IP56. (When used with IP Enclosures fans & filters)



Compact Air Filters

Part Number	Description	Size
Standard	Item description	H x W x D (mm)
IP-ALFAKR120	Compact filter unit w/ standard filter mat	125 x 125 x 10
IP-ALFAKR120R	Compact filter unit w/ metallic filter mesh	125 x 125 x 10



Sun Shields

STEEL



STAINLESS STEEL

Part Number	Size	Part Number Suffix	Part Number	Size
Standard	H x W x D (mm)	Optional Colours	Standard	H x W x D (mm)
IP-SUN504020	500 x 400 x 200	-T33 -OR -RED	IP-SUNSS504020	500 x 400 x 200
IP-SUN606030	600 x 600 x 300	-T34 -OR -RED	IP-SUNSS606030	600 x 600 x 300
IP-SUN806030	800 x 600 x 300	-T35 -OR -RED	IP-SUNSS806030	800 x 600 x 300



Ventilated Roofs

STEEL



ALUMINIUM



Part Number	Part Number	Size	Part Number Suffix
Standard	Standard	W x D (mm)	Optional Colour
IP-VR6040	IP-AVR6040	600 x 400	-T33
IP-VR8040	IP-AVR8040	800 x 400	-T33
IP-VR10040	IP-AVR10040	1000 X 400	-

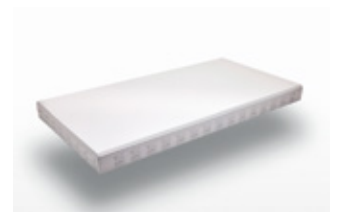

Accessories

LED

LED Surface Mounted Luminaires

24V DC

IP Enclosures provide high quality LED Surface Mounted Luminaires for electrical enclosures.

Features:

- Very bright LED luminaire
- 24V DC
- Homogenous, uniform, & flicker-free illumination
- Slim, almost non-protruding LED luminaire; 25 mm high
- Clear cover; polycarbonate-material; shatterproof
- Available in clear cover glare suppression
- Quick installation (single solution/electrically interlinkable; cascadable)
- Robust aluminium housing for heat dissipation
- Made in Germany

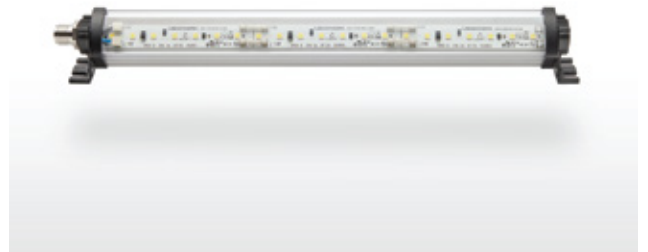

Features	Unit	IP-LED01-24VDC	IP-LED02-24VDC	IP-LED03-24VDC	IP-LED04-24VDC	IP-LED05-24VDC	IP-LED06-24VDC
Power Supply	V	24V DC					
Luminosity	Lm	145 Lm/W					
Lamp luminous flux	Lm	630 Lm	945 Lm	1260 Lm	1890 Lm	2835 Lm	3780 Lm
Lamp type	-	LED Surface-mounted Luminaire					
Illuminant	-	SMD LED					
Light distribution	-	Direct					
Light colour	-	Daylight white (5200-5700K)					
Beam angle (optics)	-	120°					
Colour rendering	Ra	>85					
Power consumption	W	~4 W	~6 W	~8 W	~13 W	~19 W	~24 W
Service life	hr	>60,000 h					
Electrical connection	-	M12 A-type encoded					
Housing material	-	Aluminium					
Cover material	-	Polycarbonate; clear; shatterproof					
Protection degree/Class	-	IP54 / Class III					
Operating temperature	°C (°F)	-10...+60 °C					
Mounting	-	Swivel / Planar mounting					
Installation	-	Electrical Interlinked					
Dimensions	mm	180(L) x 26(W) x 31(H)	260(L) x 26(W) x 31(H)	350(L) x 26(W) x 31(H)	520(L) x 26(W) x 31(H)	760(L) x 26(W) x 31(H)	1020(L) x 26(W) x 31(H)
Net weight	kg	0.18	0.20	0.30	0.35	0.50	0.70
Gross weight	kg	0.33	0.35	0.45	0.60	0.80	1.00
Conformity/Certifications	-	CE; ETL Listed					



IP ENCLOSURES PTY LTD

ABN 17 168 921 319

Head Office: 19-27 Fren Chaplin Circuit, Bells Creek QLD 4551

sales@ipenclosures.com.au | www.ipenclosures.com.au

T: 1300 576 094 | + 61 7 5450 1489

GLOBAL DISTRIBUTION: UK Europe USA UAE NZ Asia-Pacific