

SECTION AV-AV

FRONT VIEW

RIGHT SIDE VIEW

SECTION AU-AU

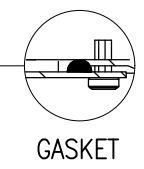

GASKET

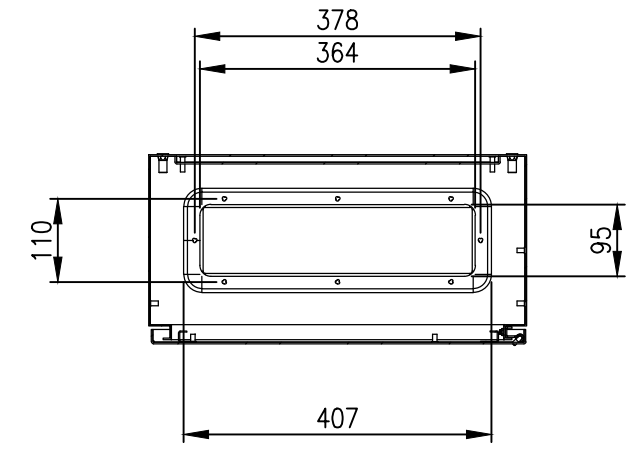

SECTION AY-AY

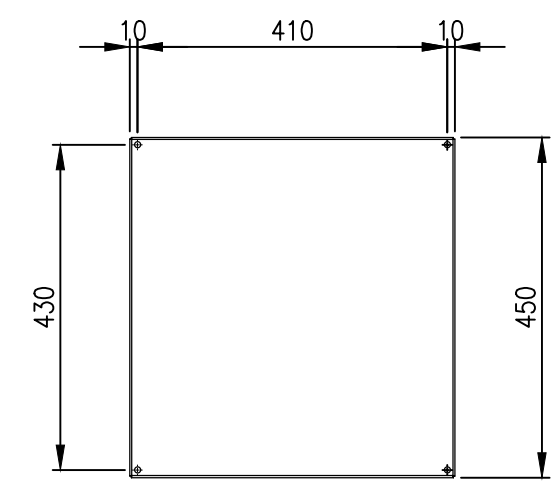

MOUNTING PLATE
(PAINTED TO RAL9010)

MATERIAL
 BODY: 2.0mm GALVANISED STEEL SHEET
 DOOR: 2.0mm GALVANISED STEEL SHEET
 MOUNTING PLATE: GALVANISED STEEL SHEET
 GLAND PLATE: 2.0mm GALVANISED STEEL SHEET
 SEAL: POLYURETHANE

PROTECTION: IP66 IK10, NEMA 4
 STANDARD: IEC62208, IEC/EN/AS60529

© IP ENCLOSURES 2022.
 THIS DRAWING SHALL NOT BE COPIED OR REPRODUCED WITHOUT
 AUTHORISATION FROM IP ENCLOSURES.
 www.ipenclosures.com.au

Itemref	Quantity	Title/Name, designation, material, dimension etc			Article No./Reference
Designed by IP	Checked by IP	Approved by - date 29/07/22	Filename IP-SSR50525-HD-OR	Date 29/07/22	Scale 1:10
		500x500x250 HD STEEL SLOPING ROOF ENCLOSURE			
		IP-SSR50525-HD-OR		Edition 0	Sheet 1/1