

RevNo	Revision note	Date	Signature	Checked
0	GENERAL REVISION		IP	IP

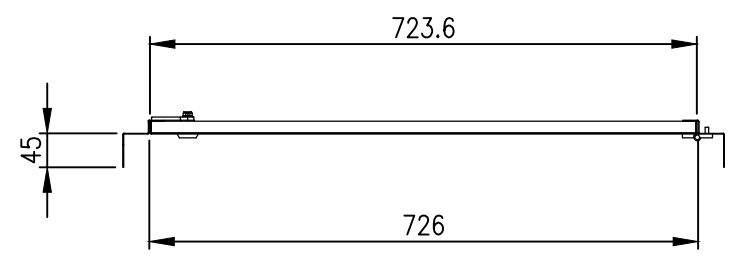

TOP VIEW

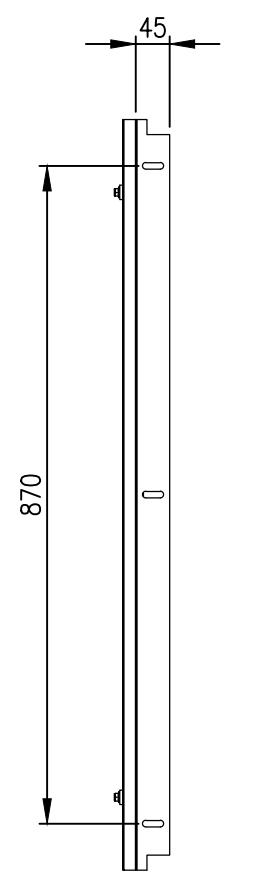

LEFT SIDE VERTICAL FRAME

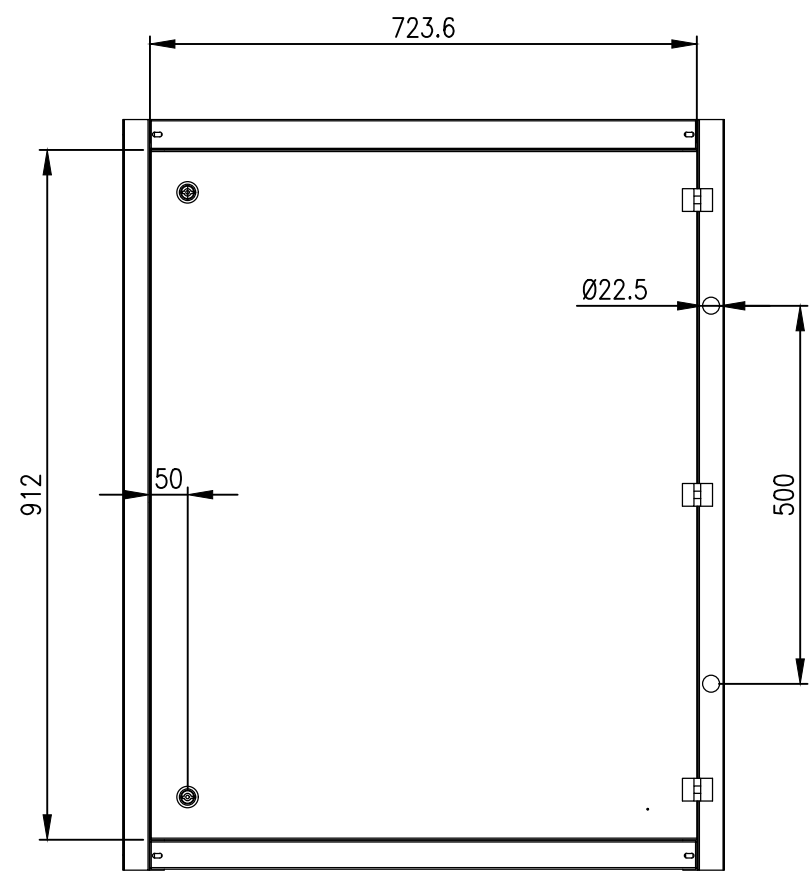

FRONT VIEW

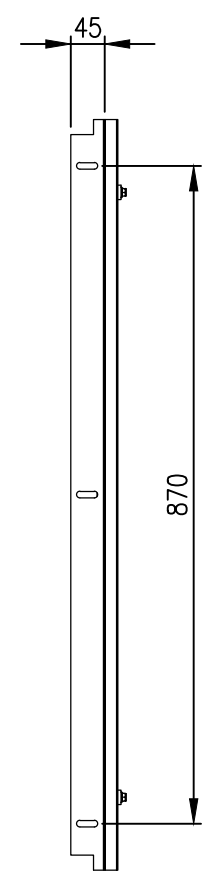

RIGHT SIDE VERTICAL FRAME

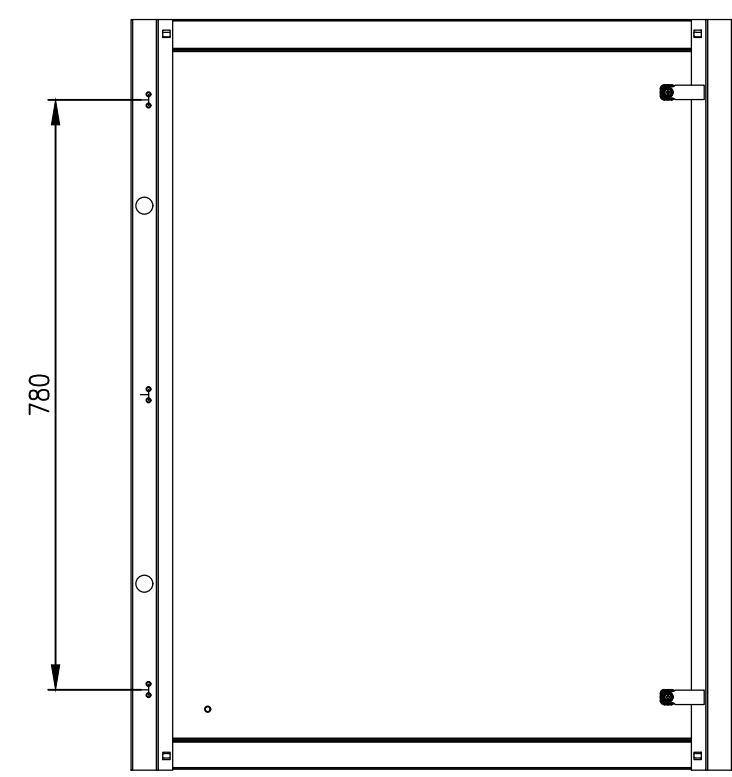

REAR VIEW

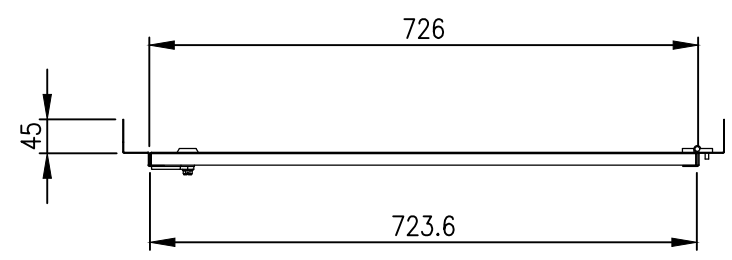

BOTTOM VIEW

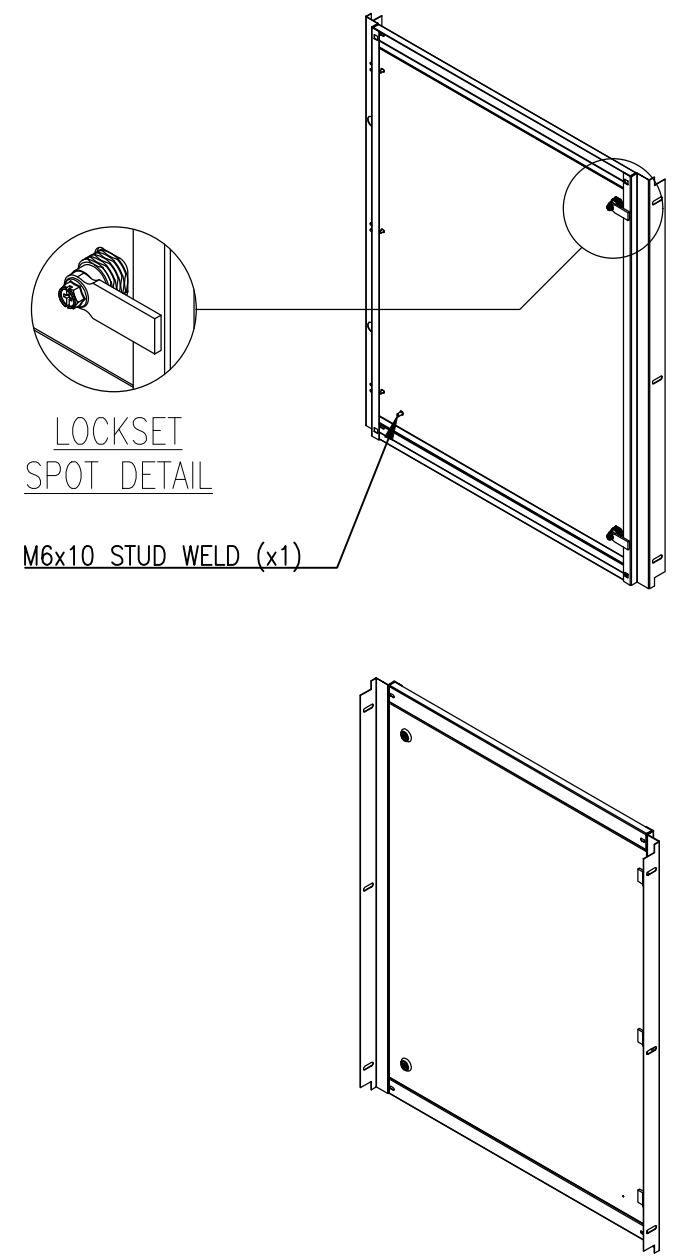

LOCKSET SPOT DETAIL

M6x10 STUD WELD (x1)

**MATERIAL**  
 FRAME: 1.5mm 315 STAINLESS STEEL  
 DOOR PANEL: 1.5mm 316 STAINLESS STEEL

**CLEARANCE/DISTANCE DIMENSIONS:**  
 -INNER DOOR TO OUTER DOOR: 68mm  
 -INNER DOOR TO MOUNTING PLATE:  
 -(ENCLOSURE WITH 300 DEPTH): 217.2mm  
 -(ENCLOSURE WITH 400 DEPTH): 317.2mm

© IP ENCLOSURES 2022.  
 THIS DRAWING SHALL NOT BE COPIED OR REPRODUCED  
 WITHOUT AUTHORISATION FROM IP ENCLOSURES.  
 www.ipenclosures.com.au

Itemref	Quantity	Title/Name, designation, material, dimension etc	Article No./Reference
Designed by IP	Checked by IP	Approved by - date 11/07/22	Filename IP-SSD10080
		Date 11/07/22	Scale 1:10
			1000Hx800W 316SS INNER DOOR
IP-SSD10080			Edition 0
			Sheet 1/1