

RevNo	Revision note	Date	Signature	Checked
1	GENERAL REVISION	9/8/17	IP	IP

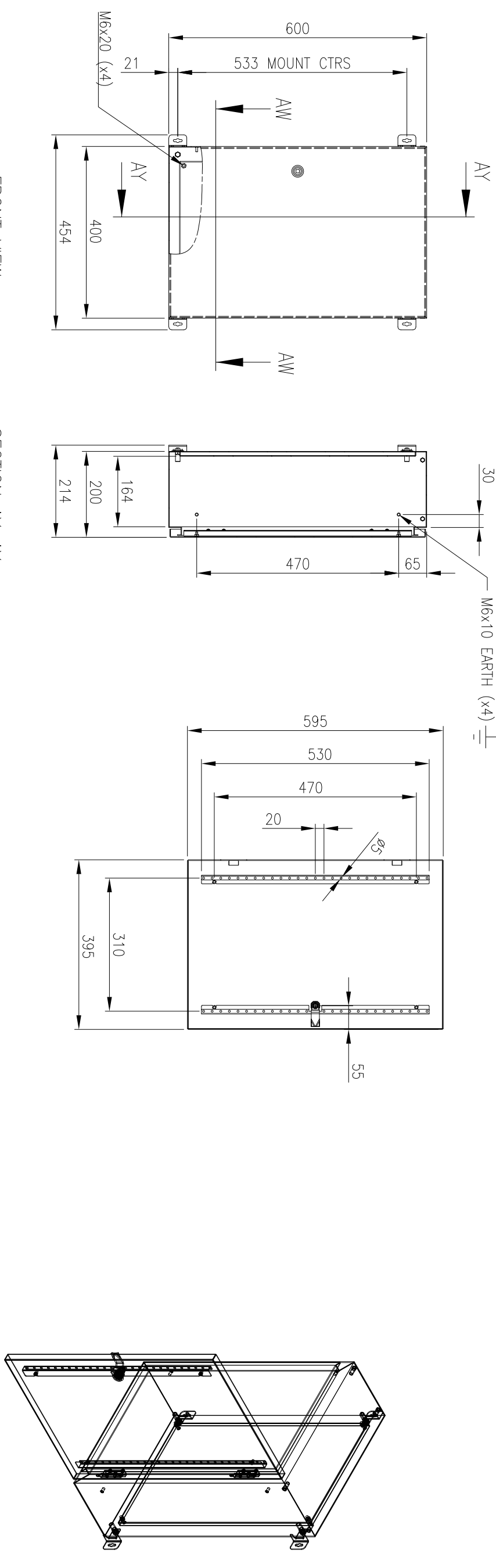

FRONT VIEW

SECTION AY-AY

INSIDE DOOR VIEW

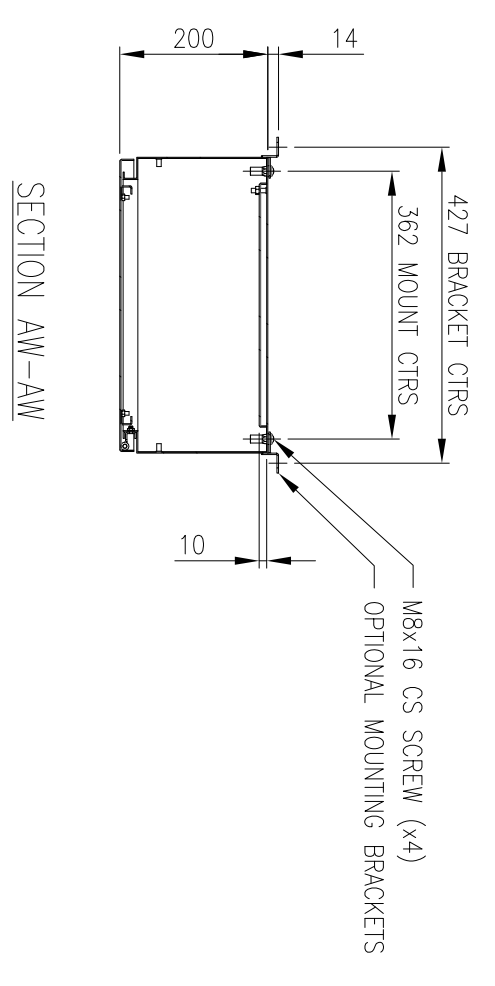

SECTION AW-AW

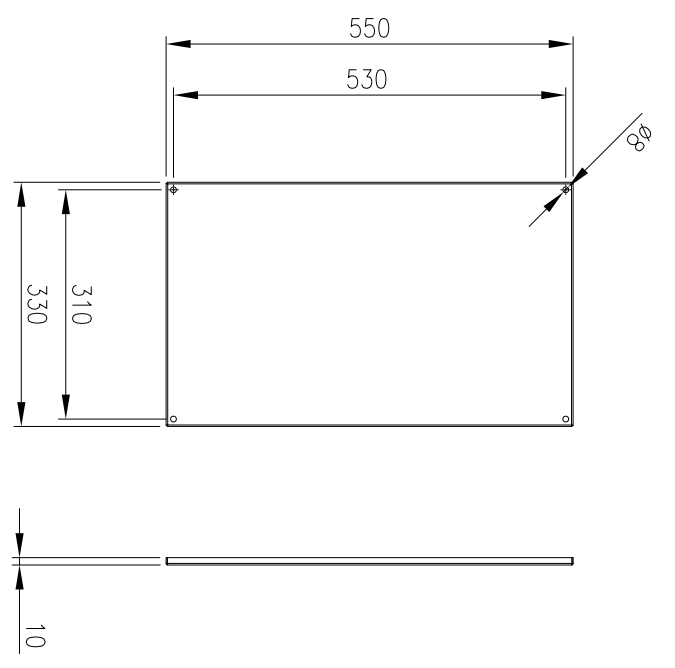

DEVICE MOUNTING PLATE

MATERIAL
 BODY: 1.5mm 316 STAINLESS STEEL
 DOOR: 1.5mm 316 STAINLESS STEEL
 DEVICE PLATE: 1.5mm GALV STEEL
 SEAL: POLYURETHANE

MASS: 15.0kg

PROTECTION: IP66 IK10, NEMA4x
 STANDARD: IEC/EN/AS62208, IEC/EN/AS60529

© IP ENCLOSURES 2016.
 THIS DRAWING SHALL NOT BE COPIED OR REPRODUCED
 WITHOUT AUTHORISATION FROM IP ENCLOSURES.
 www.ipenclosures.com.au

Item	Quantity	TradeName, designation, material, dimension etc.	Article No./Reference	Scale
IP Enclosures				1:10
Designed by	Checked by	Approved by - date	Filename	Date
IP	IP	17/10/16	IP-SS604020-01	17/10/16
			600X400X200 316SS ENCLOSURE	
			IP-SS604020-01	
			1	1/1