

RevNo	Revision note	Date	Signature	Checked
0	GENERAL REVISION		IP	IP

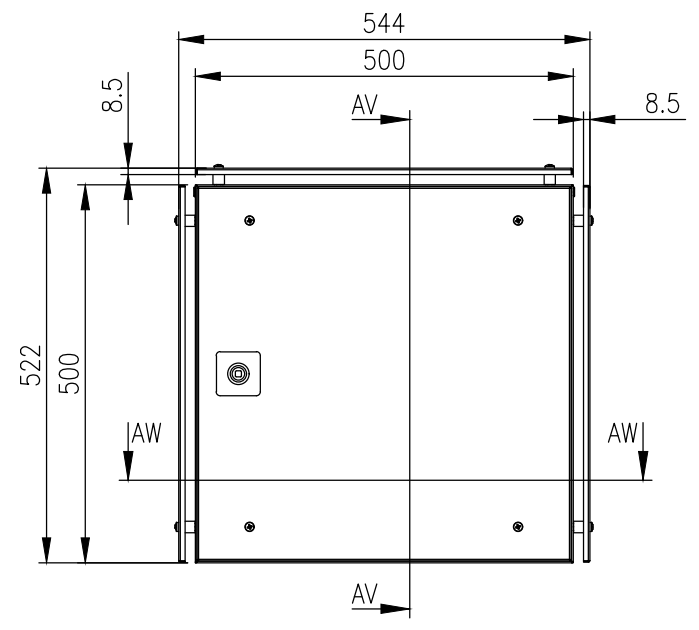

FRONT VIEW



FRONT VIEW

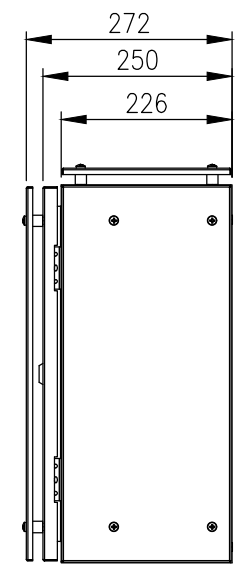

RIGHT SIDE VIEW

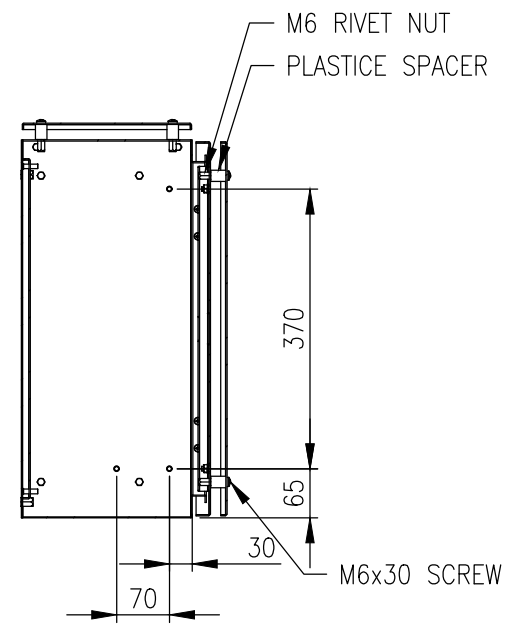

SECTION AV-AV

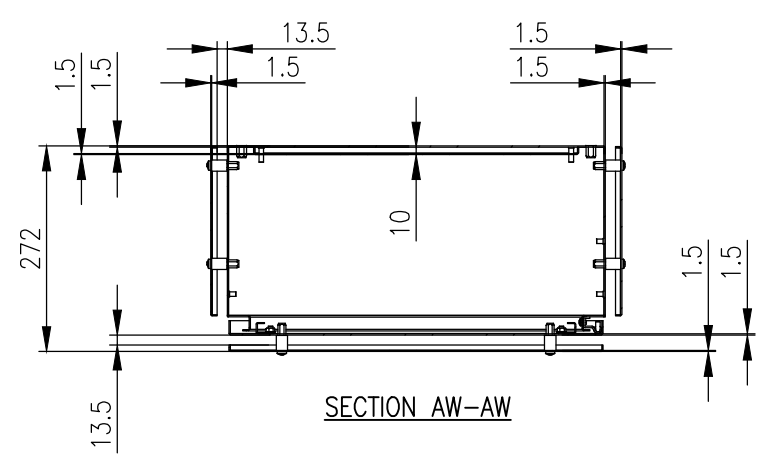
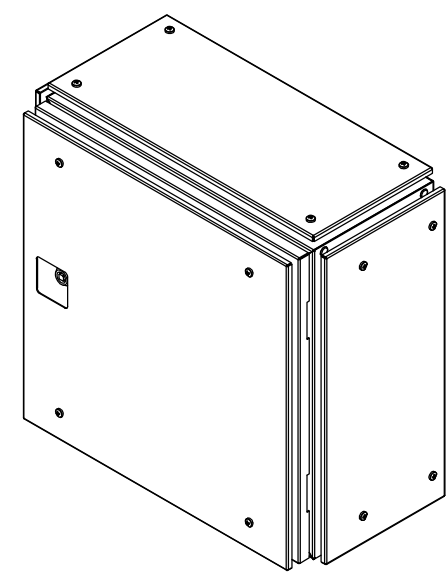

SECTION AW-AW

MATERIAL
 BODY: 1.5mm GRADE 316L STAINLESS STEEL
 DOOR: 1.5mm GRADE 316L STAINLESS STEEL
 SUN SHIELDS: 1.5mm GRADE 316L STAINLESS STEEL with STAINLESS STEEL FASTENERS
 DEVICE PLATE: 1.5mm GALVANISED STEEL SHEET
 SEAL: POLYURETHANE

MASS: 23.8Kg.

PROTECTION: IP66 IK10 (NEMA 4x)
 STANDARD: IEC/EN62208, IEC/EN/AS60529

© IP ENCLOSURES 2025.
 THIS DRAWING SHALL NOT BE COPIED OR REPRODUCED
 WITHOUT AUTHORISATION FROM IP ENCLOSURES.
 www.ipenclosures.com.au

Itemref	Quantity	Title/Name, designation, material, dimension etc	Article No./Reference
Designed by IP	Checked by IP	Approved by - date 19/03/25	Filename IP-SS505025SUN
		Date 19/03/25	Scale 1:10
			500x500x250 316SS ELECTRICAL ENCLOSURE with SUNSHIELDS IP-SS505025SUN
			Edition 0 Sheet 1/1