

# SS1 Electrical Enclosure

# IP-SS504020SUN

STAINLESS STEEL | SINGLE DOOR | IP66 IK10 | WITH SUN SHIELDS 500H x 400W x 200D

The SS1 range of stainless steel electrical enclosures with sun shields are rated for protection up to IP66 and are aimed to reduce heat from direct sunlight. This range is equipped with sun shields fitted to the external surfaces to help regulate the internal temperature of the electrical enclosure when exposed to direct sunlight.

**Protection:** IP66 IK10 (NEMA 4x)

**Standards (& Conformities):** IEC/EN 60529, IEC/EN 62208, IEC/EN 61439, RoHS



**Material:**

- Body: 1.5mm Grade 316L stainless steel
- Door: 1.5mm Grade 316L stainless steel
- Sun Shields: 1.5mm Grade 316L stainless steel with stainless steel fasteners
- Device Mounting Plate: 1.5mm galvanised steel sheet
- Gland Plate: 1.5mm galvanised steel sheet
- Seal: Polyurethane

**Surface Finish:** 0.4 micron Ra surface brushed finish.

**Enclosure Body & Sun Shields:** The robust monoblock body is fabricated using 1.5mm Grade 316L stainless steel (Grade 304 is also available). Flat face sealing surfaces are provided to increase seal life. Pre-fitted blind nuts are incorporated to accommodate mounts and accessory fasteners to eliminate drilling and retain IP rating. Integral device plate mounts and M6 earth studs are provided. Sun shields are fabricated using 1.5mm Grade 316L stainless steel sheet and are provided with spacers to offset the surface of the shield from the surface of the enclosure. Cutting, pressing and full continuous seam welding using precision automated manufacturing equipment ensures accuracy and consistent high quality.

**Enclosure Door:** The robust surface mounted door is fabricated using 1.5mm Grade 316L stainless steel and incorporates concealed removable hinges with captive pins (Grade 304 is also available). The door is designed for a 110° opening. Each door contains cable management rails, an M6 earth stud and a high quality machine-applied foamed in place (FIP) Polyurethane seal. Two internal cable management rails can be removed to provide additional space for equipment, duct and door mounted control components. Sun shields are fabricated using 1.5mm Grade 316L stainless steel sheet and are provided with spacers to offset the surface of the shield from the surface of the enclosure.

**Enclosure Seal:** A high-quality machine-applied full perimeter UL listed Polyurethane seal foamed in place (FIP) provides excellent sealing over a long life. Temperature resistance -40°C to 80°C (160°C short term loading).

**Enclosure Lock:** Grade 316 stainless steel 8mm square drive quarter turn lock with key.

**Device Mounting Plate:** The device mounting plate is 1.5mm galvanised steel sheet. It is pressed to provide strength and supplied pre-fitted into the enclosure as standard.

**Mass:** 18.5Kg.

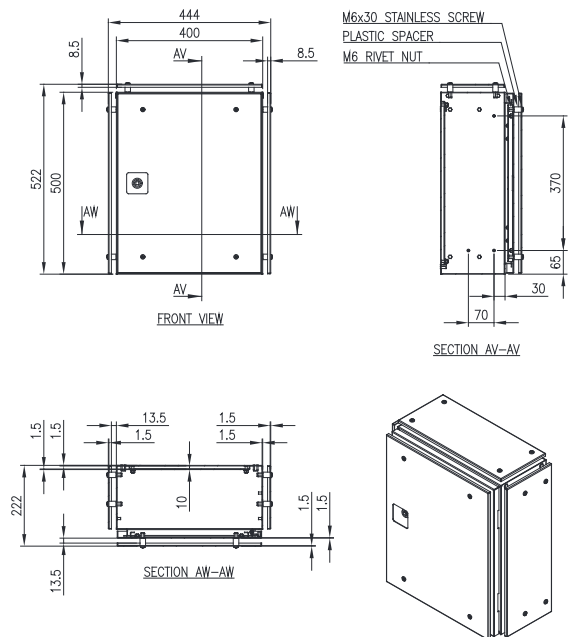

# SS1 Electrical Enclosure

# IP-SS504020SUN

STAINLESS STEEL | SINGLE DOOR | IP66 IK10 | WITH SUN SHIELDS 500H x 400W x 200D

## ACCESSORIES:

Part Number	Description
IP-SSID5040	316 Stainless Steel Inner Door (To suit Enclosure 500mmH x 400mmW)
IP-DINRAIL 7.5X35-330	DIN RAIL x 330mm (Pack of 10)
IP-EK01	Standard Earthing Kit
IP-SSWMBKIT	316 Stainless Steel Wall-Mounting Bracket Kit (with 4x Brackets and Fasteners)
IP-SSPMP400	316 Stainless Steel U-Channel Profile 400mm Long
IP-SSPMB	316 Stainless Steel Pole Mount Bracket to Suit Large Diameter Poles (Use with Bandit Strap)
IP-L031	316 Stainless Steel Wing Knob Padlockable

## CERTIFICATES:

IEC 60529 Degrees of protection provided by enclosures: Certificate AB-0386-T 1902.14 02/00  
IEC/EN 62208 Empty Enclosures for low-voltage switchgear and controlgear assemblies: Certificate 0366932-TSE-01/01  
IEC/EN61439-1, 61439-2 low voltage switchgear and controlgear assemblies: Certificate AB-0341-T, 23-297-R1-N1-1  
CE Certificate of Compliance: Certificate SZL-21 MA 13338-1  
UKCA Certificate of Compliance: Certificate SZU-22 MA 19560-1  
UL: Listing Number E534557

## IEC/EN 61439 Certified Test Ratings:

Rated Voltage: 400 V AC  
Rated Insulation Voltage: 690 V  
Rated Impulse Withstand Voltage: 6 kV  
Rated Current: 630A  
Rated Peak Withstand Voltage: 40kA  
Rated Short-Time Withstand Current: 20kA (Busbar)  
Rated Conditional Short Circuit Current: 20kA  
Rated Frequency: 50Hz

Products are manufactured to Quality, Safety and Environmental Standards.

**WARRANTY:** 5 years.