

SS2 Electrical Enclosure

IP-SS12012030

STAINLESS STEEL | DOUBLE DOOR | IP55

1200H x 1200W x 300D

IP Enclosures SS2 Range of grade 316
Stainless Steel electrical enclosures are suitable for general industrial applications.

Protection: Complies with IP55 IK10, NEMA 4x.
(Independent accredited test laboratory)

Standard: IEC/EN/AS62208, IEC/EN/AS60529, (IEC/EN/AS61439 Compliant, Optional UL508A) **CE**

Material:

- Body: 1.5mm Grade 316/316L Stainless Steel
- Door: 1.5mm Grade 316/316L Stainless Steel
- Device Mounting Plate: 1.5mm galvanised steel sheet
- Seal: Polyurethane

Surface Finish: 0.4 micron Ra surface brushed finish

Body: The robust monoblock body is fabricated using 1.5mm Grade 316/316L Stainless Steel. Flat face sealing surfaces are provided to increase seal life. Pre-fitted blind nuts are incorporated to accommodate mounts and accessory fasteners to eliminate drilling and retain IP rating. Integral device mounting plate mounts and M6 earth stud is provided.

Double Doors: The robust surface mounted doors are fabricated using 1.5mm Grade 316/316L Stainless Steel and incorporates concealed removable hinges with captive pins. The doors are designed to eliminate the central mullion to improve accessibility into the enclosure. The doors are designed for a 110° opening. Each door contains integral cable management rail studs, M6 earth stud.

Seal: A high quality machine-applied continuous foamed in place (FIP) Polyurethane seal provides excellent sealing over a long life.

Lock: 3 point locking system with key-lock swing handle.

Device Mounting Plate: The device mounting plate is fabricated using 1.5mm galvanised steel sheet, pressed to provide additional strength and supplied pre-fitted into enclosure as standard.

Mass: 70.0kg

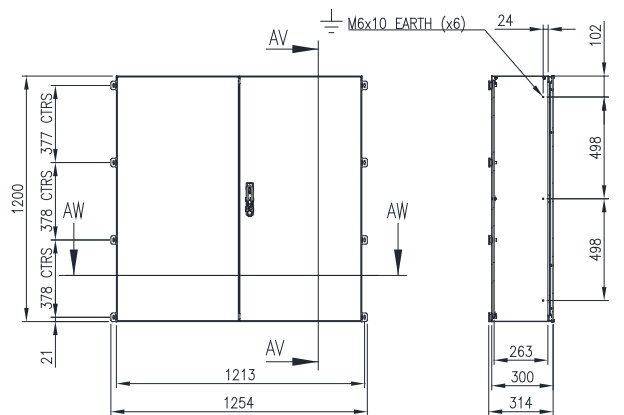

FRONT VIEW

SECTION AV-AV

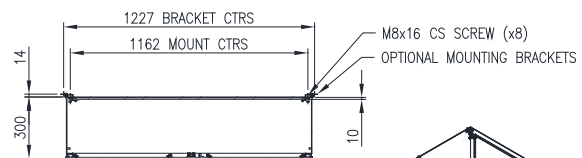

SECTION AW-AW

