

RevNo	Revision note	Date	Signature	Checked
1	GENERAL REVISION	28/02/23	IP	IP

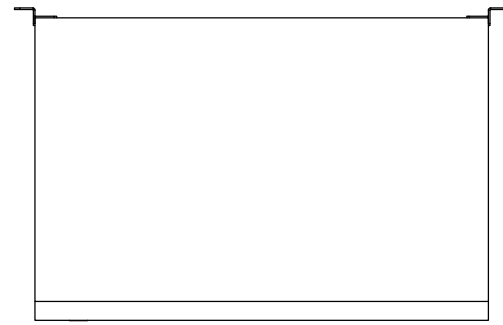

PLAN

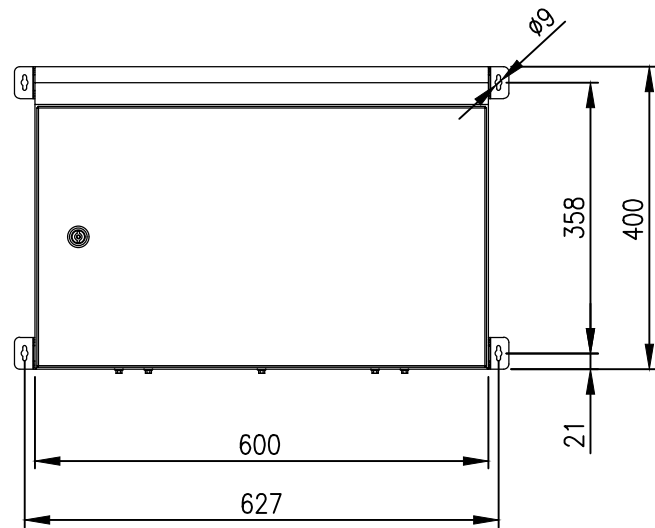
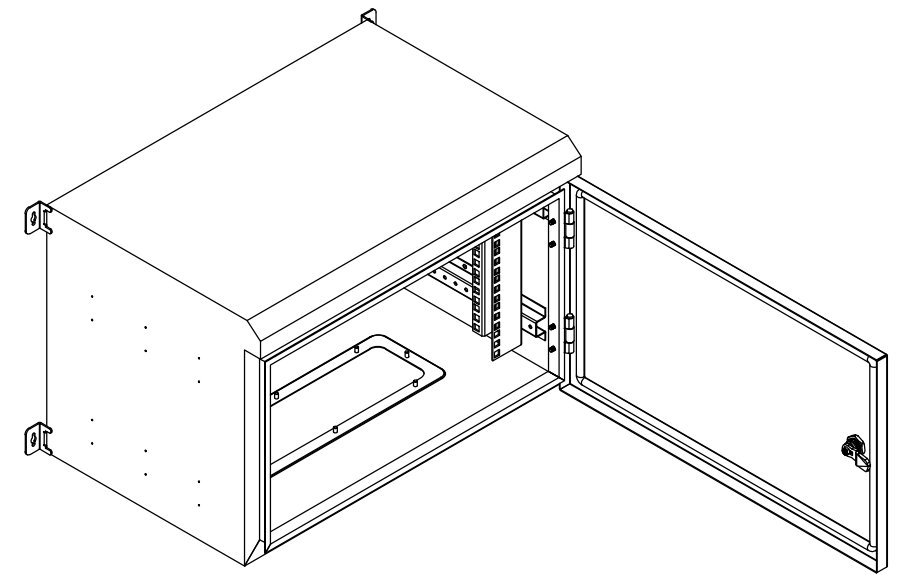

FRONT VIEW

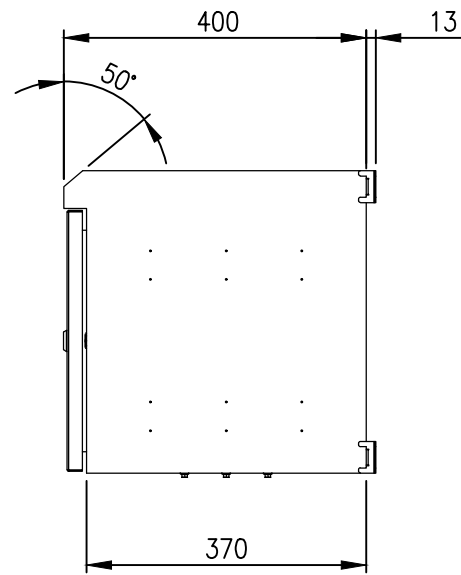

SIDE VIEW

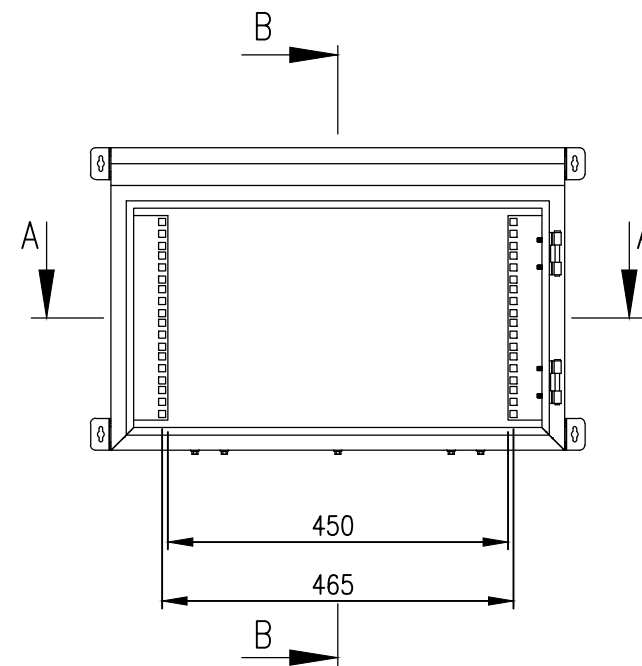

FRONT VIEW - DOOR REMOVED

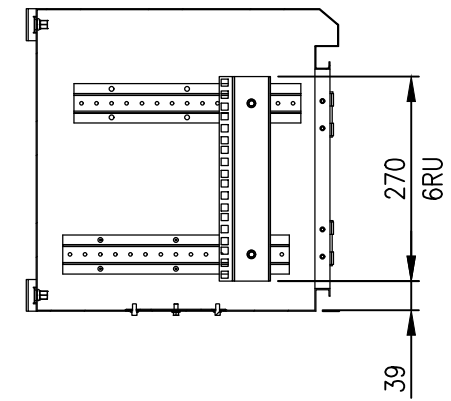

SECTION BB

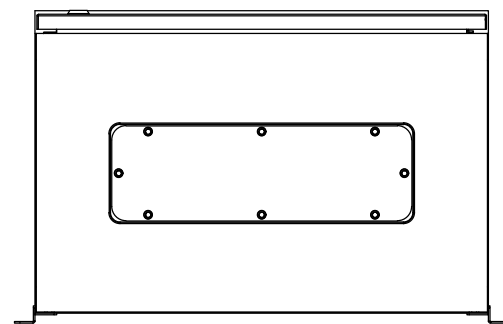

BOTTOM VIEW

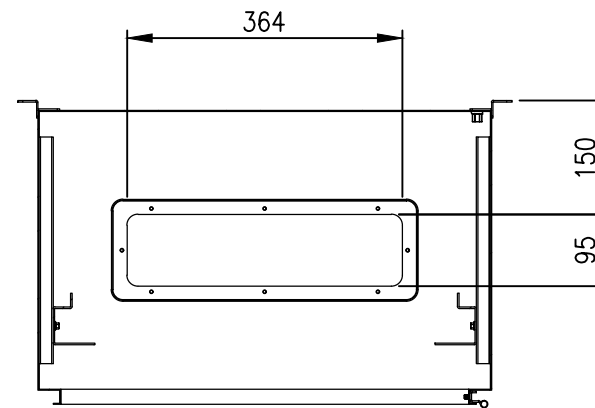

SECTION AA

MATERIAL
 BODY: 1.5mm GALVANISED STEEL SHEET
 DOOR: 1.5mm GALVANISED STEEL SHEET
 19" RAILS: 1.5mm GALVANISED STEEL SHEET
 SEAL: POLYURETHANE
 SURFACE TREATMENT: POWDER-COAT 80-120micron
 COLOR: RAL 9005 JET BLACK

PROTECTION: IP66 IK10, NEMA 4
STANDARD: EIA-310-D, IEC/EN/AS60529

© IP ENCLOSURES 2016.
 THIS DRAWING SHALL NOT BE COPIED OR REPRODUCED
 WITHOUT AUTHORISATION FROM IP ENCLOSURES.
 www.ipenclosures.com.au

Itemref	Quantity	Title/Name, designation, material, dimension etc	Article No./Reference
Designed by IP	Checked by IP	Approved by - date 16/09/19	Filename IP-SDW6RU40-BLK Date 16/09/19 Scale 1:10
			6RU 19" DATA RACK 400 DEEP IP-SDW6RU40-BLK Edition 1 Sheet 1/1