

19" Data Rack Accessories IP-SDDINPANEL3

DIN TERMINAL RAIL | STEEL

3RU (To suit 19" Racks)

The IP Enclosures range of 19" rack-mounted DIN Rail, distribution panels and shelves provide flexibility to fit DIN electrical and control components into 19" racks.

Standard: Compatible with 19" Racks EIA-310-D, RoHS

Unit Size: 3RU

Slotted DIN Rail Material:

- Electrogalvanised steel 7.5 x 35 RoHS Compliant.
- Width: Standard 35mm wide symmetrical TS35 DIN Rail compatible with EN50022 and DIN46277-3.

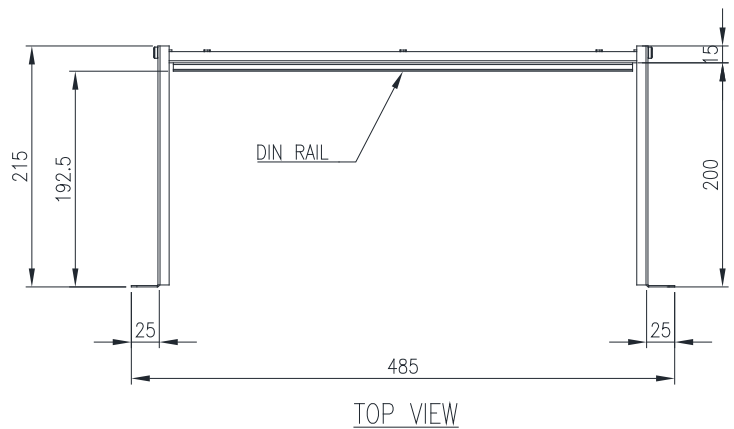
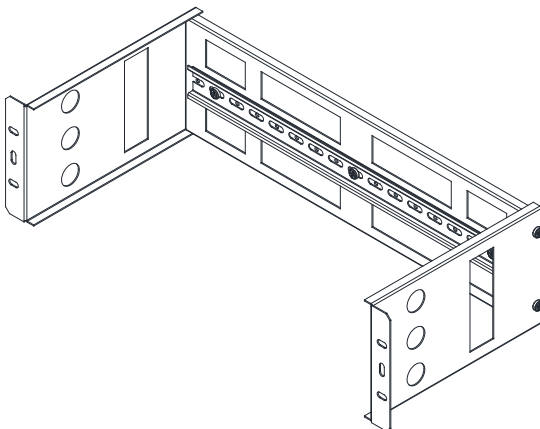

TOP VIEW

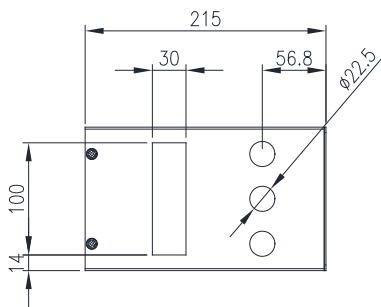

LEFT SIDE VIEW

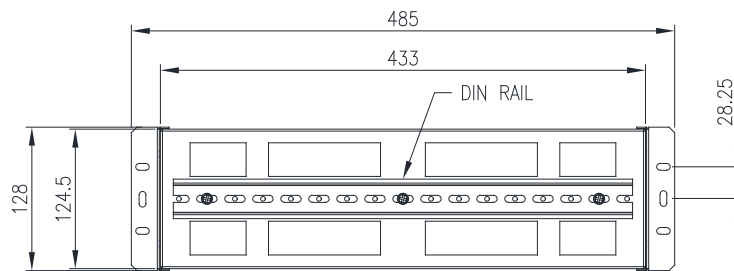

FRONT VIEW