

INNER DOOR | STEEL | WALL MOUNTED

1000H x 800W

The IP Enclosures ID Range of steel inner door escutcheons are designed and manufactured to easily fit into any IP Enclosures wall mounted electrical enclosure without drilling. Inner Doors are tool lockable.

Material:

- Frame: 1.2mm galvanised steel sheet
- Door Panel: 1.2mm galvanised steel sheet

Lock: Chrome 5mm double bit insert quarter turn lock

Surface Treatment: UL approved epoxy polyester powder coated with a textured finish. 80-120 micron average thickness.

Standard Colour: RAL7035. Coloured Inner Doors are available if required.

Clearance/Distance Dimensions:

- Inner Door to Outer Door: 68.3mm
- Inner Door to Mounting Plate:
 - (Enclosure with 300 Depth): 217.8mm
 - (Enclosure with 400 Depth): 317.8mm

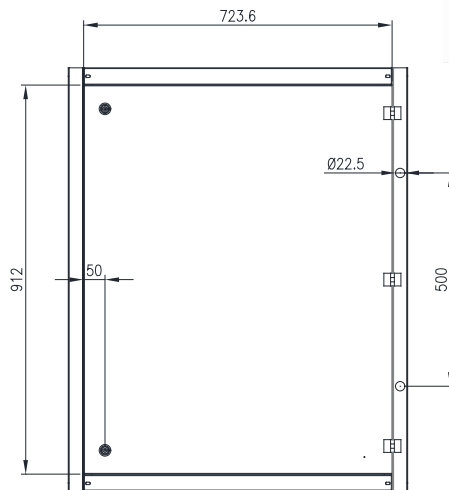

FRONT VIEW

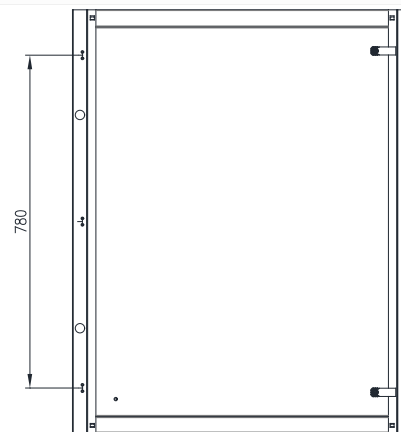

REAR VIEW

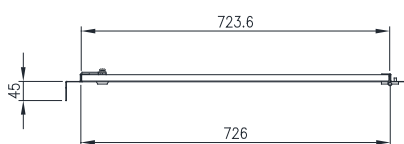

TOP VIEW

