

RevNo	Revision note	Date	Signature	Checked
1	GENERAL REVISION	9/7/19	IP	IP

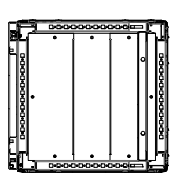

SECTION E-E

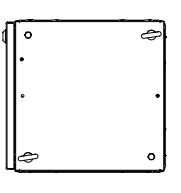

TOP VIEW

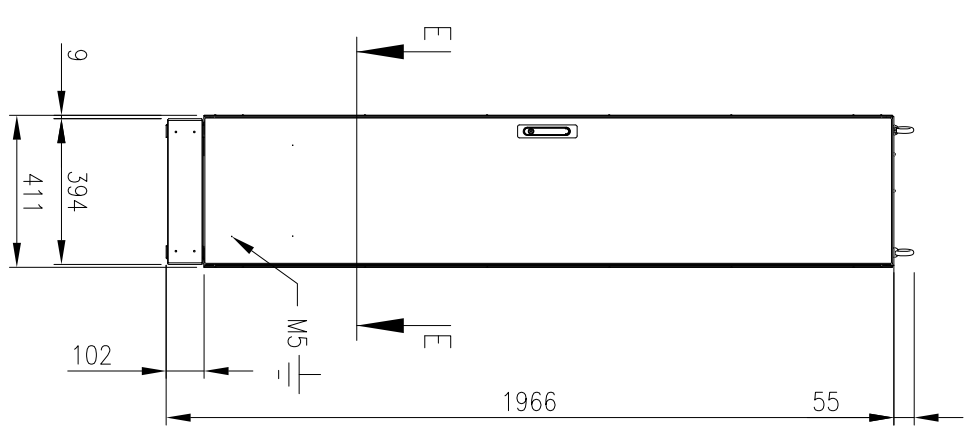

FRONT VIEW
(ASSEMBLY)

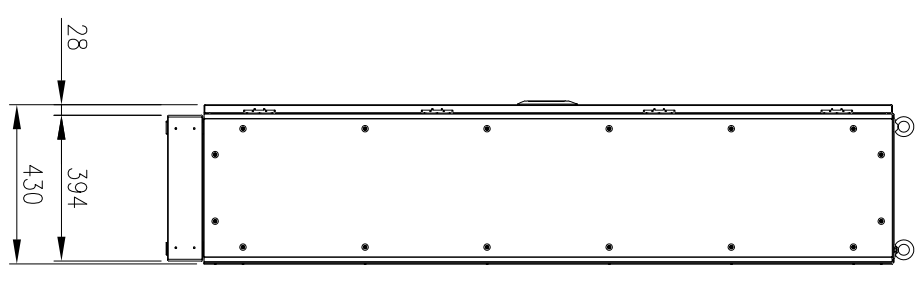

SIDE VIEW



FRONT VIEW
(PANELS REMOVED)

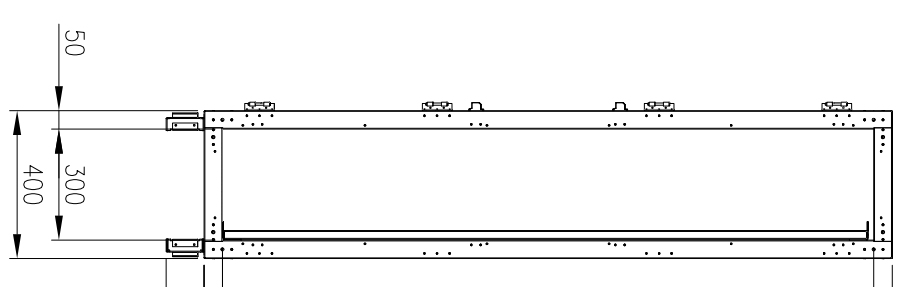

SIDE VIEW
(PANELS REMOVED)

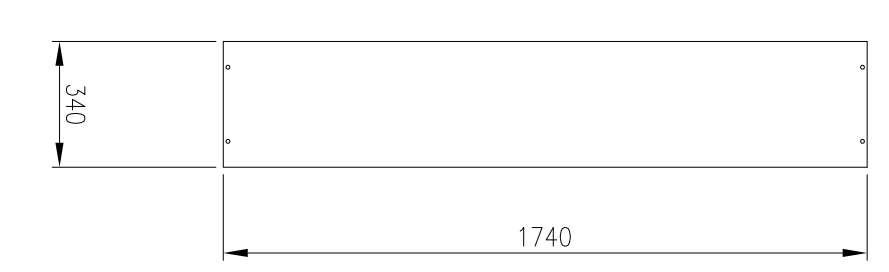
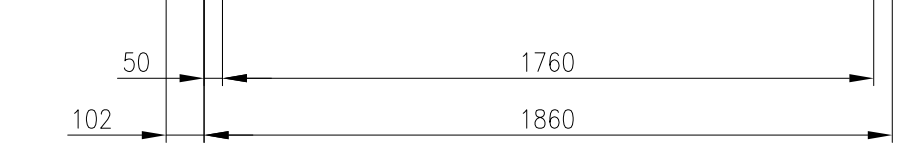

DEVICE MOUNTING PLATE

MATERIAL
 MAIN FRAME: 2.0mm 316 STAINLESS STEEL PROFILE
 PANELS: 1.2mm 316 STAINLESS STEEL
 DOOR: 2.0mm 316 STAINLESS STEEL
 MOUNTING PLATE: 2.0mm 316 STAINLESS STEEL
 SEAL: EPDM
 PROTECTION: IP55 IK10
 STANDARD: IEC62208, IEC/EN/AS60529
ORDERING INFORMATION:
 - ENCLOSURE: IP-MFSS864040
 - SIDE PANEL: IP-MFSSP18640
 - MOUNTING PLATE: IP-MFSSM18640
 - BASE: IP-MFSSB4040

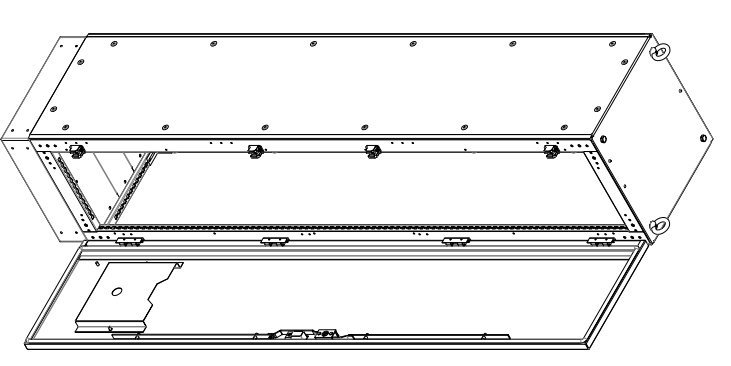

© IP ENCLOSURES 2017.
 THIS DRAWING SHALL NOT BE COPIED OR REPRODUCED
 WITHOUT AUTHORISATION FROM IP ENCLOSURES.
 www.ipenclosures.com.au

Item#	Quantity	TradeName, designation, material, dimension etc.	Article No./Reference	Scale
IP		Designed by	22/11/17	1:20
IP		Checked by	22/11/17	
		Approved by - date	22/11/17	
		Filename	1860x400x400 316SS FREESTANDING	
		Date	22/11/17	
		Article No./Reference	1860x400x400 316SS FREESTANDING	
		Edition	1	
		Sheet	1/1	

