

RevNo	Revision note	Date	Signature	Checked
1	GENERAL REVISION	9/7/19	IP	IP

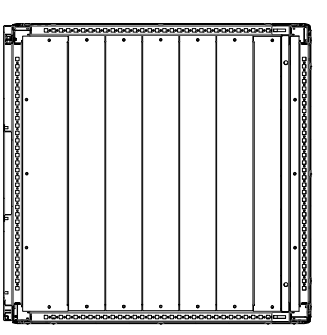

SECTION E-E

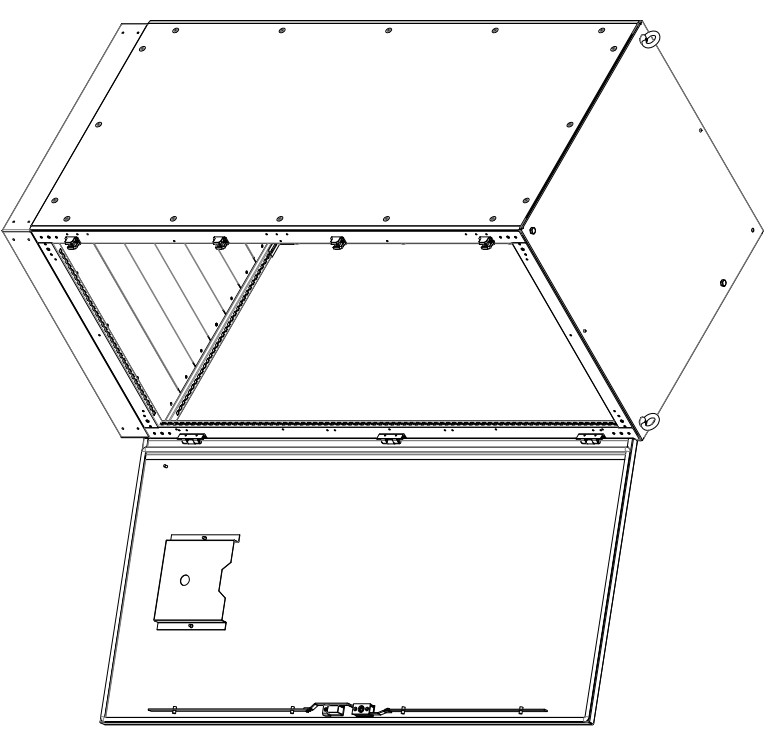
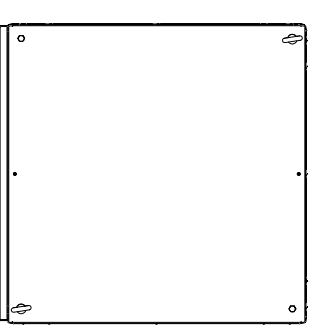

TOP VIEW

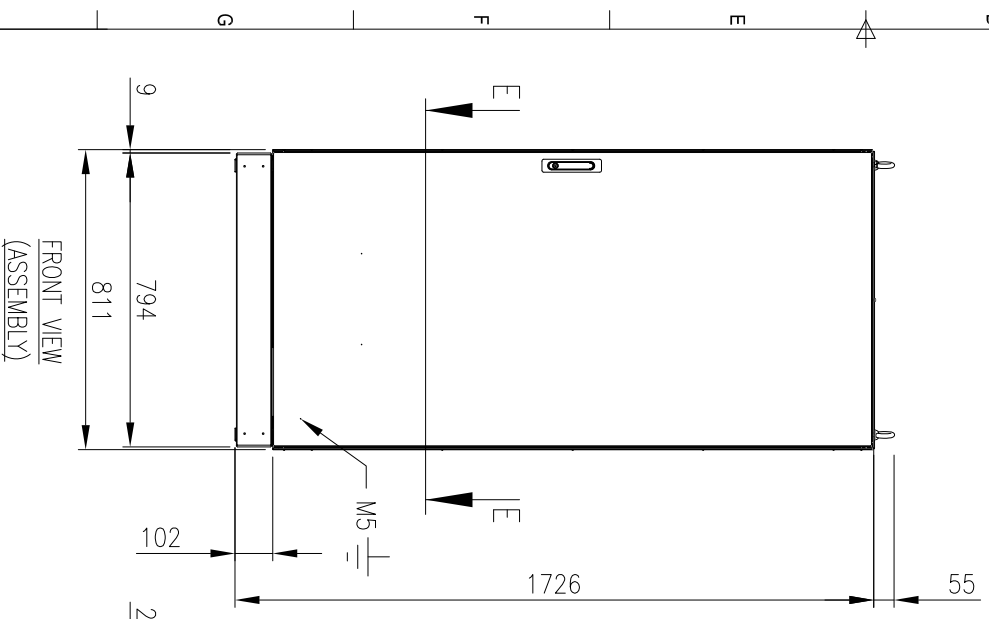

FRONT VIEW
(ASSEMBLY)

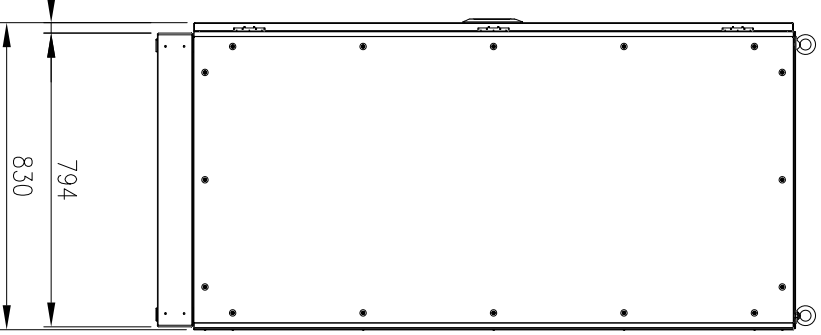

SIDE VIEW

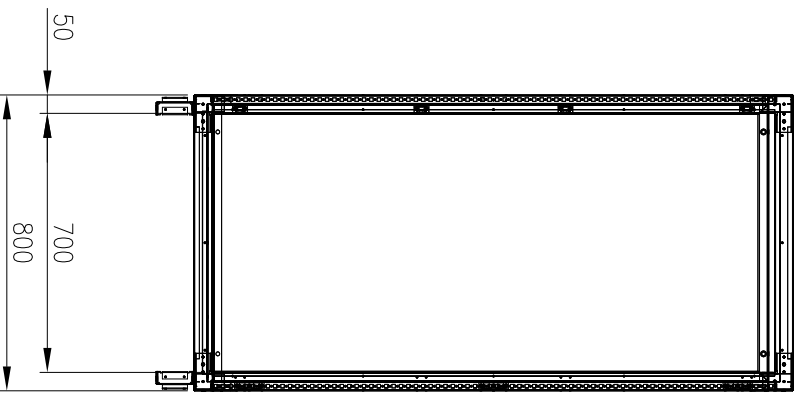

FRONT VIEW
(PANELS REMOVED)

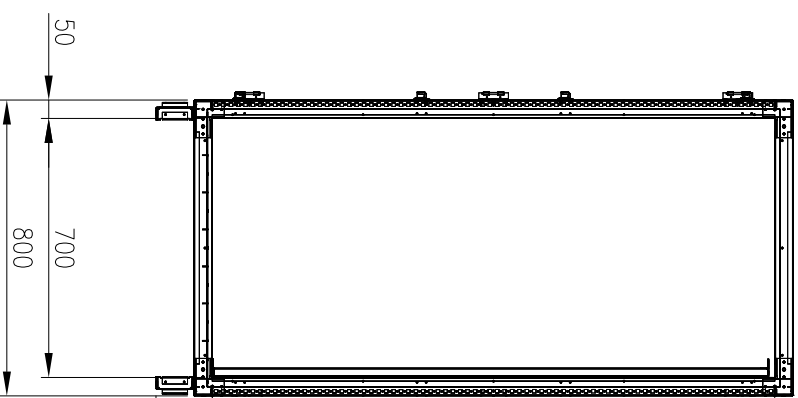

SIDE VIEW
(PANELS REMOVED)

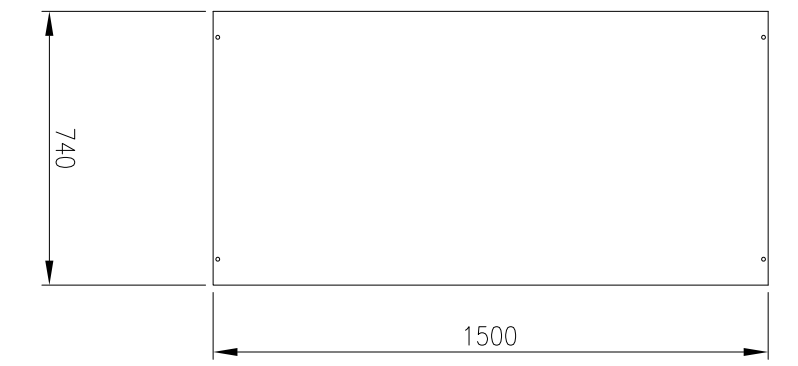
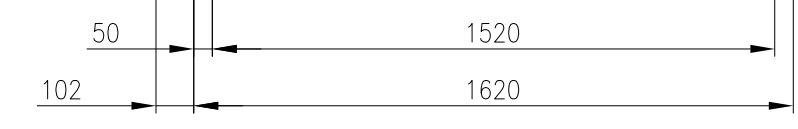

DEVICE MOUNTING PLATE

MATERIAL
 MAIN FRAME: 2.0mm 316 STAINLESS STEEL PROFILE
 PANELS: 1.2mm 316 STAINLESS STEEL
 DOOR: 2.0mm 316 STAINLESS STEEL
 MOUNTING PLATE: 2.0mm 316 STAINLESS STEEL
 SEAL: EPDM

PROTECTION: IP55 IK10
STANDARD: IEC62208, IEC/EN/AS60529

ORDERING INFORMATION:
 - ENCLOSURE: IP-MFSS1628080
 - SIDE PANEL: IP-MFSSP16280
 - MOUNTING PLATE: IP-MFSSM16280
 - BASE: IP-MFSSB8080

© IP ENCLOSURES 2017.
 THIS DRAWING SHALL NOT BE COPIED OR REPRODUCED
 WITHOUT AUTHORISATION FROM IP ENCLOSURES.
 www.ipenclosures.com.au

Item#	Quantity	TradeName, designation, material, dimension etc.	Article No./Reference	Scale
IP				1:20
Designed by	Checked by	Approved by - date	Filename	Date
IP	IP	22/11/17		22/11/17
1620x800x800 316SS FREESTANDING				1:20
IP-MFSS1628080				1
				Sheet
				1/1

