

RevNo	Revision note	Date	Signature	Checked
1	GENERAL REVISION	9/7/19	IP	IP

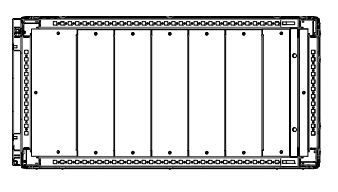

SECTION E-E

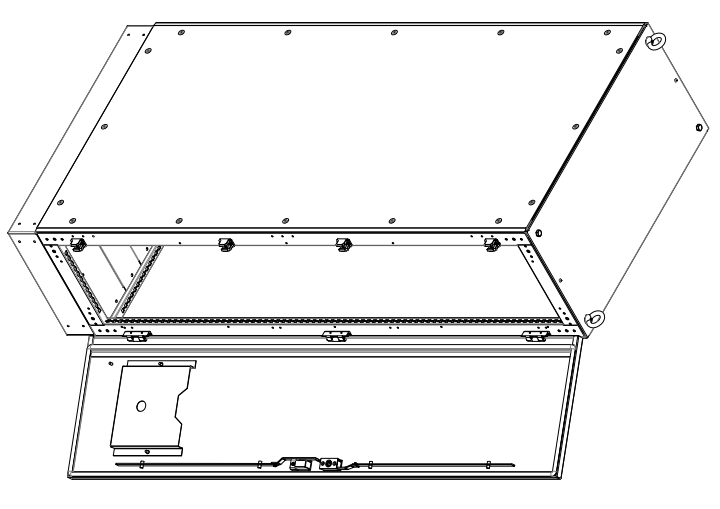
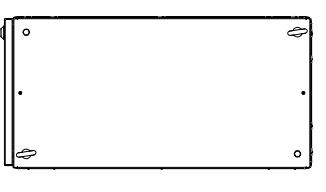

TOP VIEW

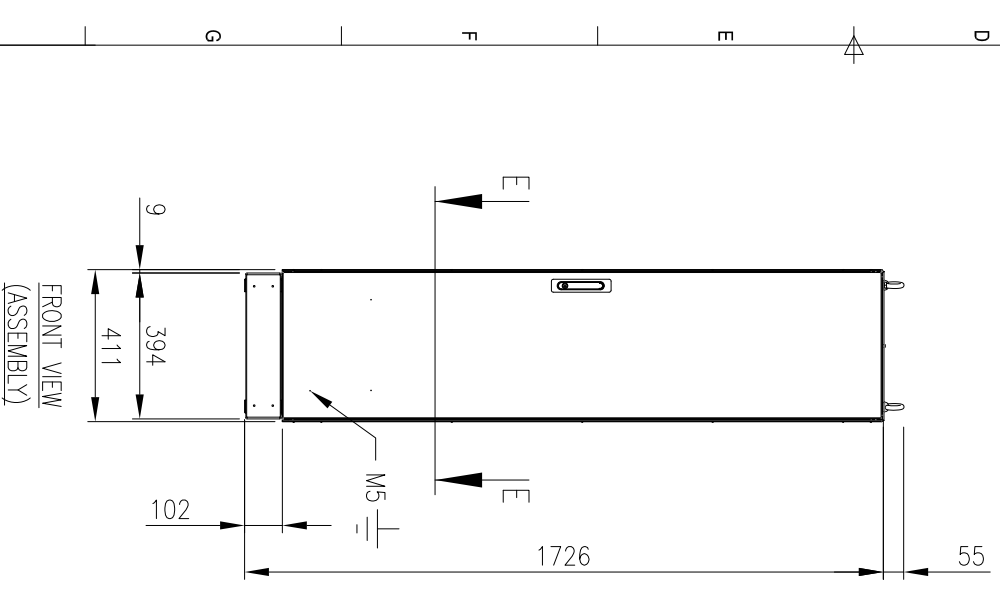

FRONT VIEW  
(ASSEMBLY)

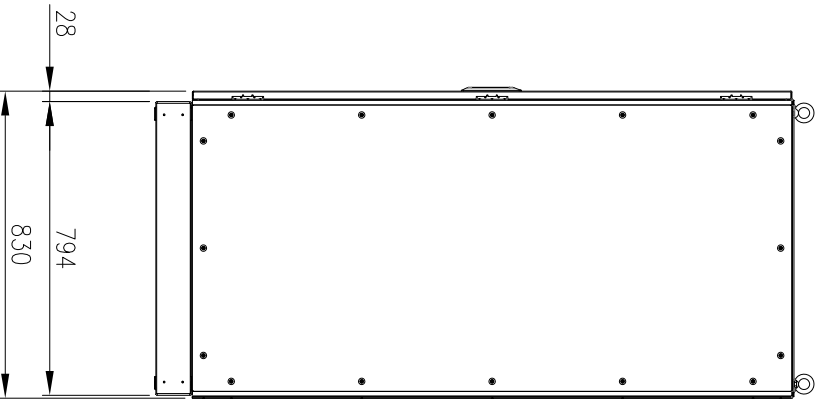

SIDE VIEW

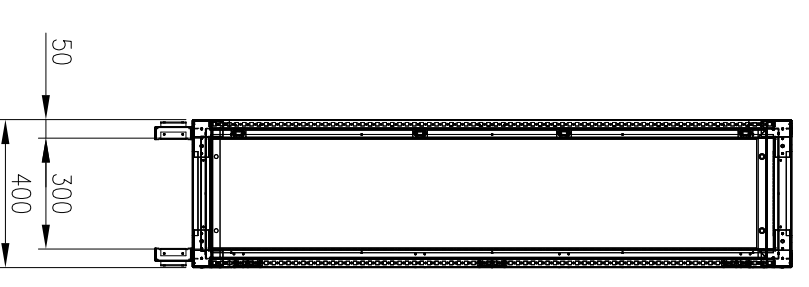

FRONT VIEW  
(PANELS REMOVED)

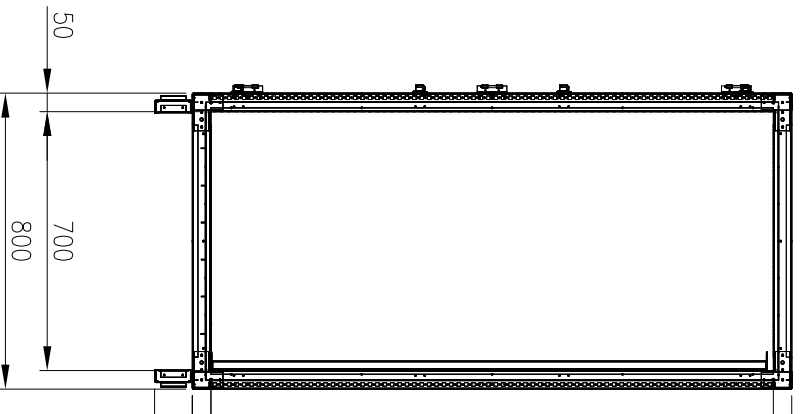

SIDE VIEW  
(PANELS REMOVED)

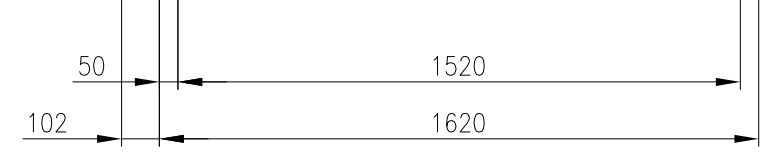

DEVICE MOUNTING PLATE



**MATERIAL**  
 MAIN FRAME: 2.0mm 316 STAINLESS STEEL PROFILE  
 PANELS: 1.2mm 316 STAINLESS STEEL  
 DOOR: 2.0mm 316 STAINLESS STEEL  
 MOUNTING PLATE: 2.0mm 316 STAINLESS STEEL  
 SEAL: EPDM  
 PROTECTION: IP55 IK10  
 STANDARD: IEC62208, IEC/EN/AS60529  
 ORDERING INFORMATION:  
 - ENCLOSURE: IP-MFSS1624080  
 - SIDE PANEL: IP-MFSSP16280  
 - MOUNTING PLATE: IP-MFSSM16240  
 - BASE: IP-MFSSB4080

© IP ENCLOSURES 2017.  
 THIS DRAWING SHALL NOT BE COPIED OR REPRODUCED  
 WITHOUT AUTHORISATION FROM IP ENCLOSURES.  
 www.ipenclosures.com.au

Item#	Quantity	PartName, designation, material, dimension etc.	Article No./Reference	Scale
IP		1620X400X800 316SS FREESTANDING		1:20
IP		IP-MFSS1624080		1/1"

