

RevNo	Revision note	Date	Signature	Checked
1	GENERAL REVISION	9/7/19	IP	IP

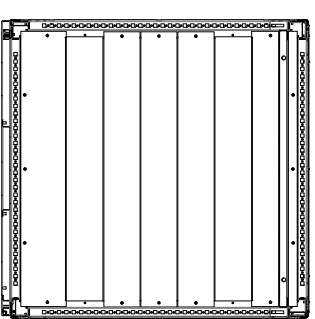

SECTION E-E

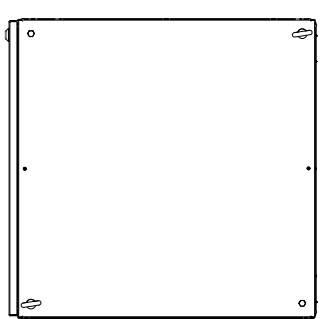

TOP VIEW

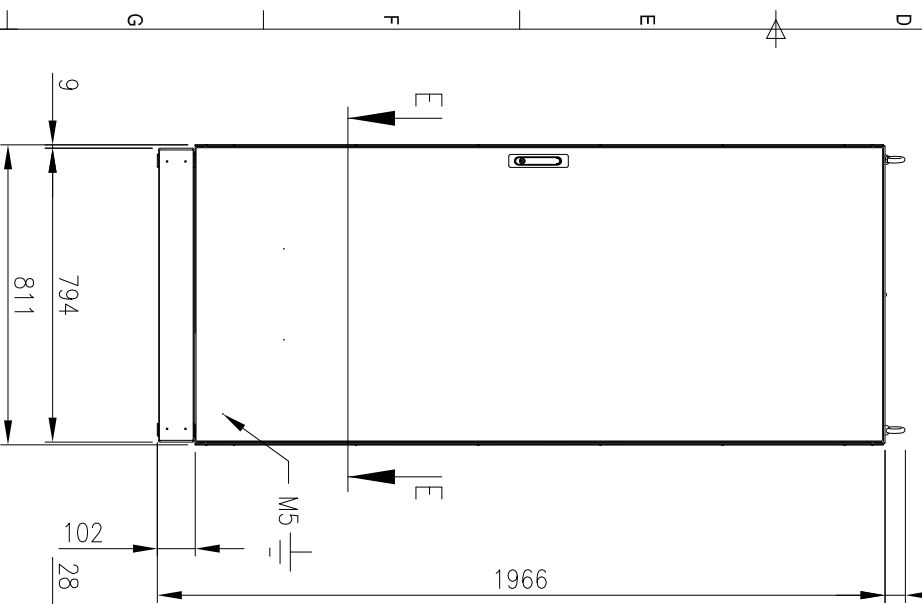

FRONT VIEW
(ASSEMBLY)

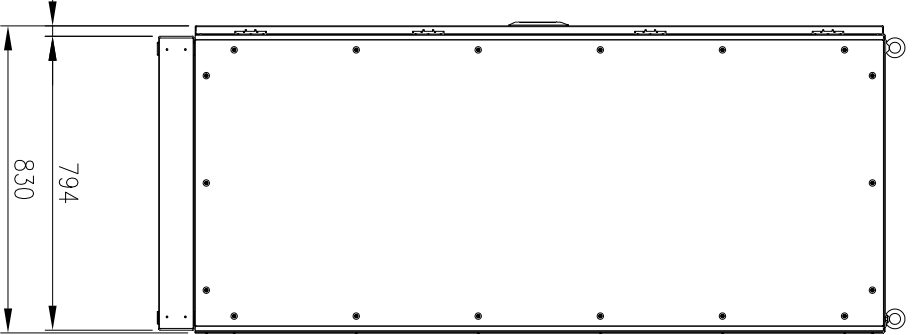

SIDE VIEW

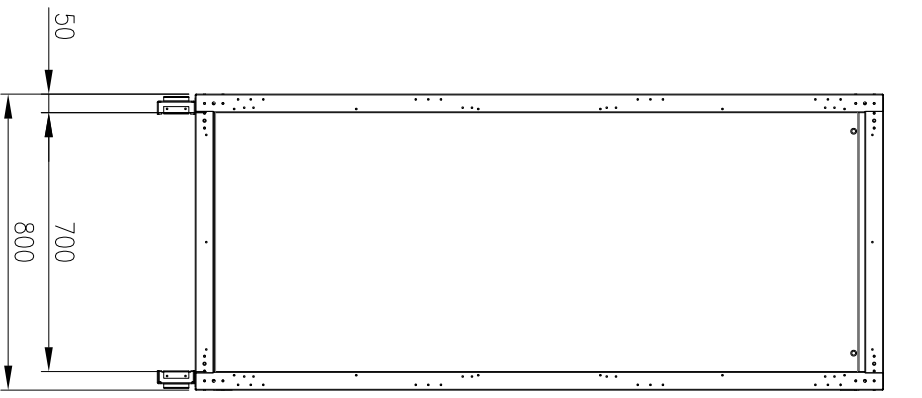

FRONT VIEW
(PANELS REMOVED)

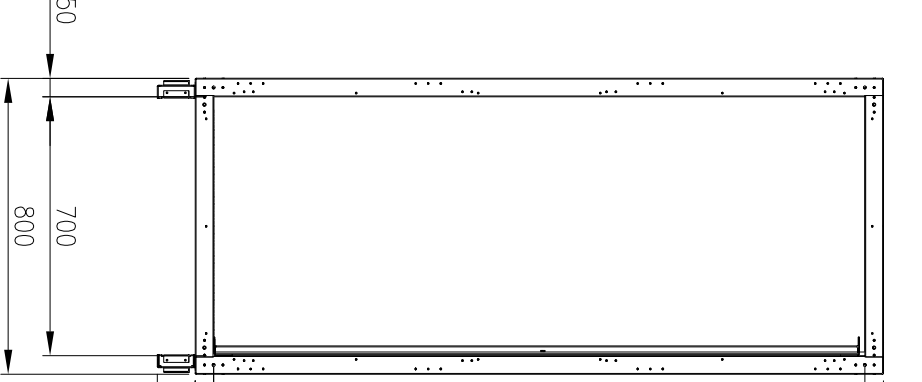

SIDE VIEW
(PANELS REMOVED)

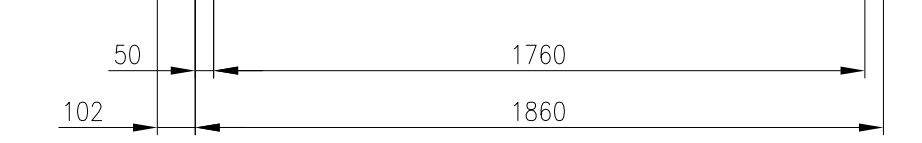

DEVICE MOUNTING PLATE

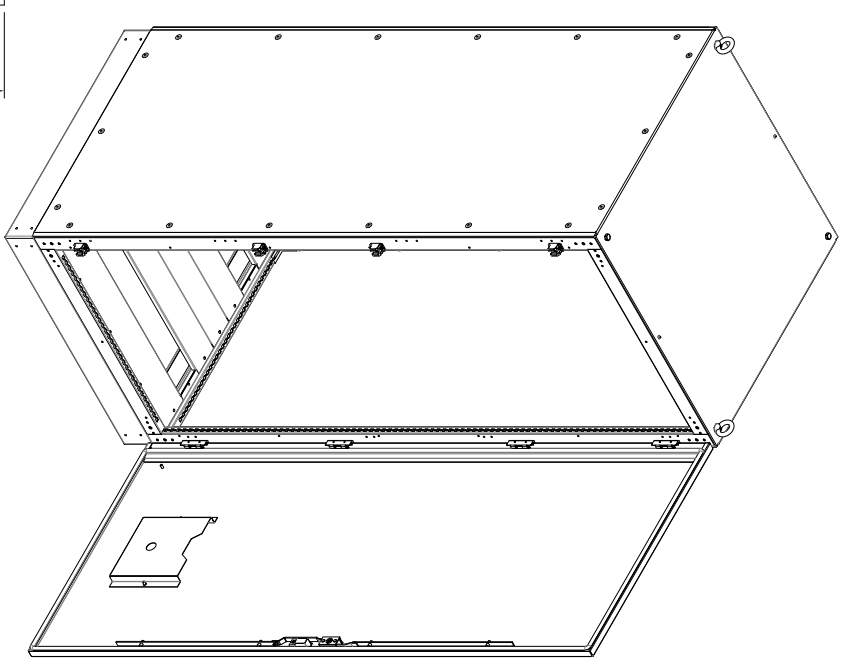

MATERIAL
 MAIN FRAME: 2.0mm GALVANISED STEEL PROFILE
 PANELS: 1.2mm POWDERCOATED GALVANISED SHEET
 DOOR: 2.0mm POWDERCOATED GALVANISED STEEL
 MOUNTING PLATE: 2.0mm GALVANISED STEEL SHEET
 SEAL: EPDM
 SURFACE TREATMENT: POWDER-COAT 80-120micron
 STANDARD COLOUR: RAL7035

PROTECTION: IP55 IK10
 STANDARD: IEC62208, IEC/EN/AS60529

ORDERING INFORMATION:
 - ENCLOSURE: IP-MFS1868080
 - SIDE PANEL: IP-MFSP18680
 - MOUNTING PLATE: IP-MFSM18680
 - BASE: IP-MFSB8080

© IP ENCLOSURES 2017.
 THIS DRAWING SHALL NOT BE COPIED OR REPRODUCED
 WITHOUT AUTHORISATION FROM IP ENCLOSURES.
 www.ipenclosures.com.au

Item#	Quantity	TradeName, designation, material, dimension etc.	Article No./Reference	Scale
IP		1860x800x800 STEEL FREESTANDING		1:20
IP		IP-MFS1868080		1/1"



1 2 3 4 5 6 7 8 9 10 11 12 13 14 15 16