

SECTION E-E

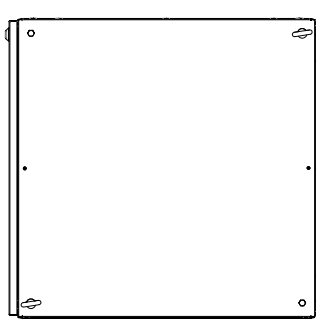

TOP VIEW

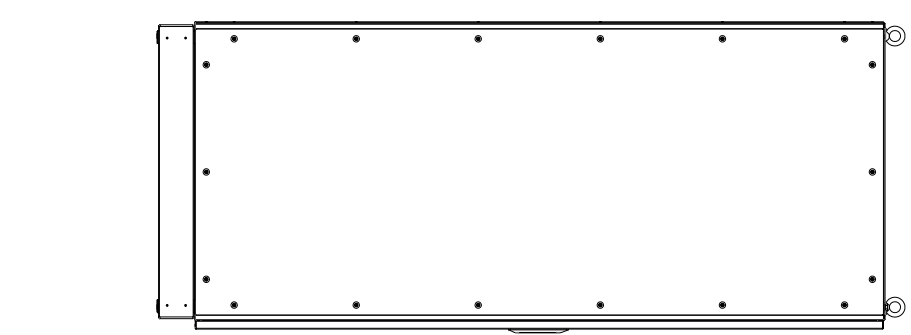

SIDE VIEW

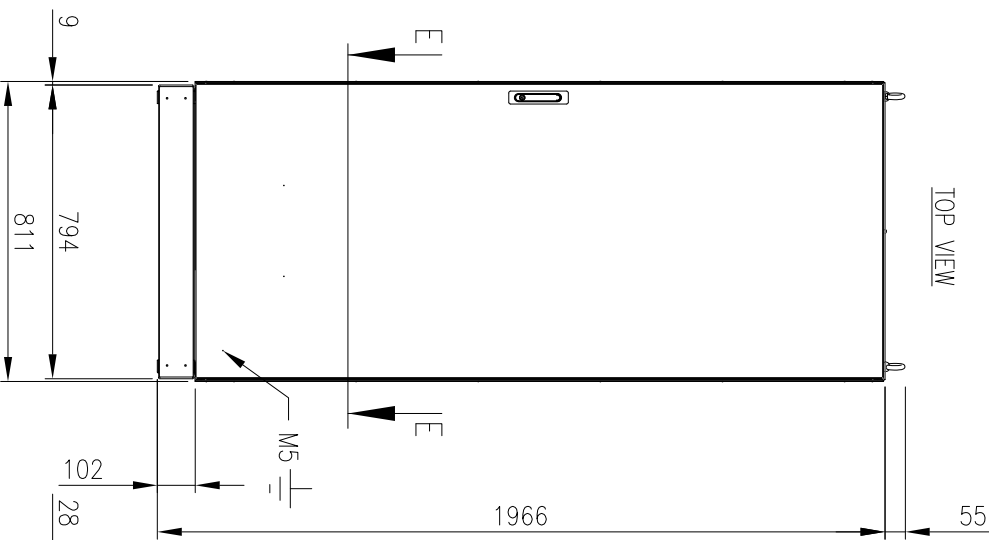

FRONT VIEW  
(ASSEMBLY)

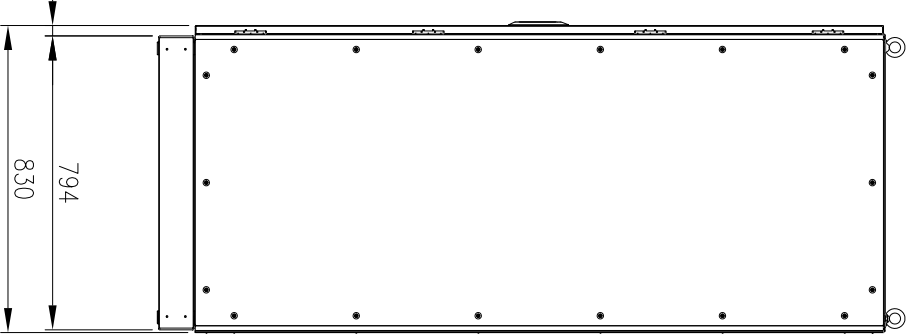

SIDE VIEW

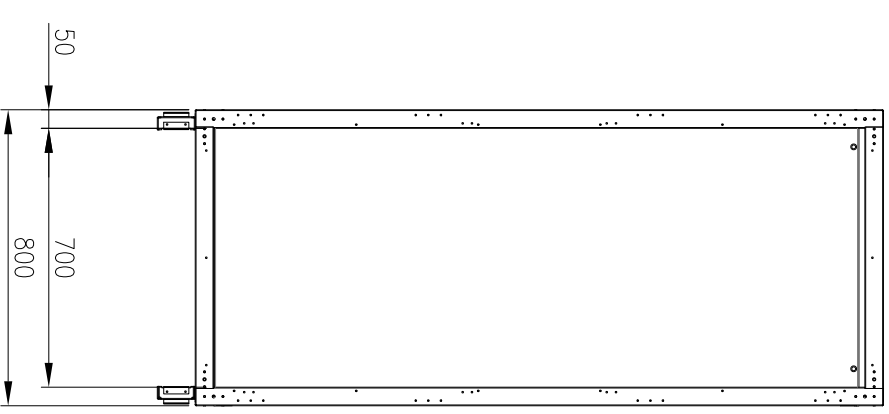

FRONT VIEW  
(PANELS REMOVED)

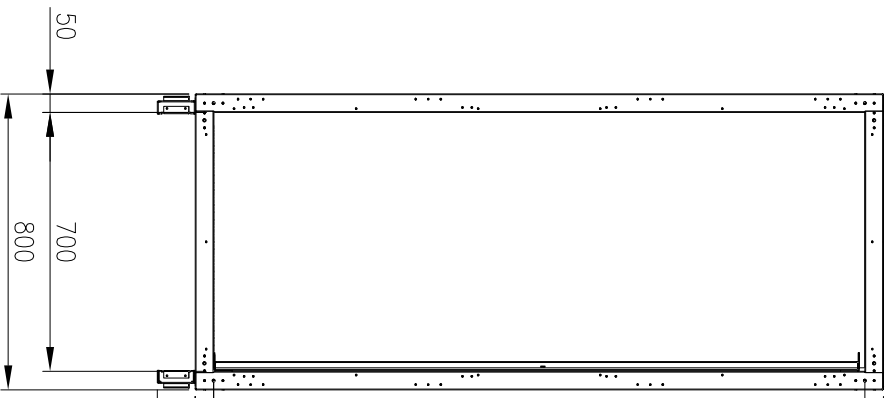

SIDE VIEW  
(PANELS REMOVED)

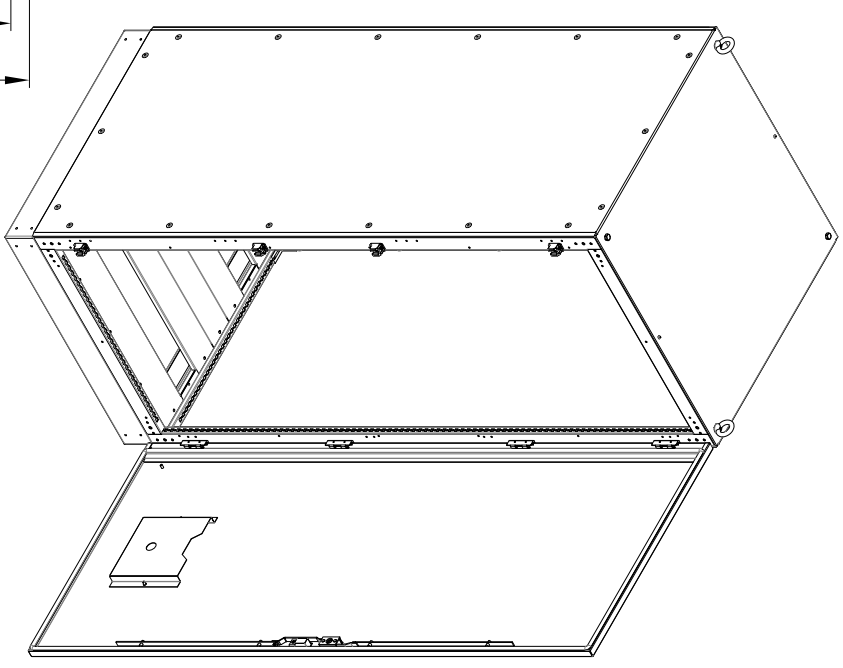

**MATERIAL**  
 MAIN FRAME: 2.0mm GALVANISED STEEL PROFILE  
 PANELS: 1.2mm POWDERCOATED GALVANISED SHEET  
 DOOR: 2.0mm POWDERCOATED GALVANISED STEEL  
 MOUNTING PLATE: 2.0mm GALVANISED STEEL SHEET  
 SEAL: EPDM  
 SURFACE TREATMENT: POWDER-COAT 80-120micron  
 STANDARD COLOUR: RAL7035

PROTECTION: IP55 IK10  
 STANDARD: IEC/EN/AS62208, IEC/EN/AS60529

ORDERING INFORMATION:  
 - ENCLOSURE: IP-MFS1868080  
 - SIDE PANEL: IP-MFSP18680  
 - MOUNTING PLATE: IP-MFSM18680  
 - BASE: IP-MFSB8080

© IP ENCLOSURES 2017.  
 THIS DRAWING SHALL NOT BE COPIED OR REPRODUCED  
 WITHOUT AUTHORISATION FROM IP ENCLOSURES.  
 www.ipenclosures.com.au

| Item# | Quantity | PartName, designation, material, dimension etc. | Article No./Reference | Scale |
|-------|----------|-------------------------------------------------|-----------------------|-------|
| IP    | 1        | 1860x800x800 STEEL FREESTANDING                 |                       | 1:20  |
| IP    | 1        | IP-MFS1868080                                   |                       | 1/1   |

