

SECTION E-E

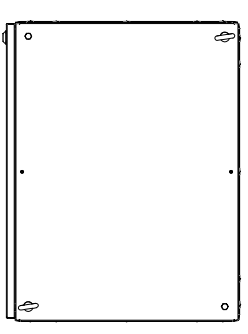

TOP VIEW

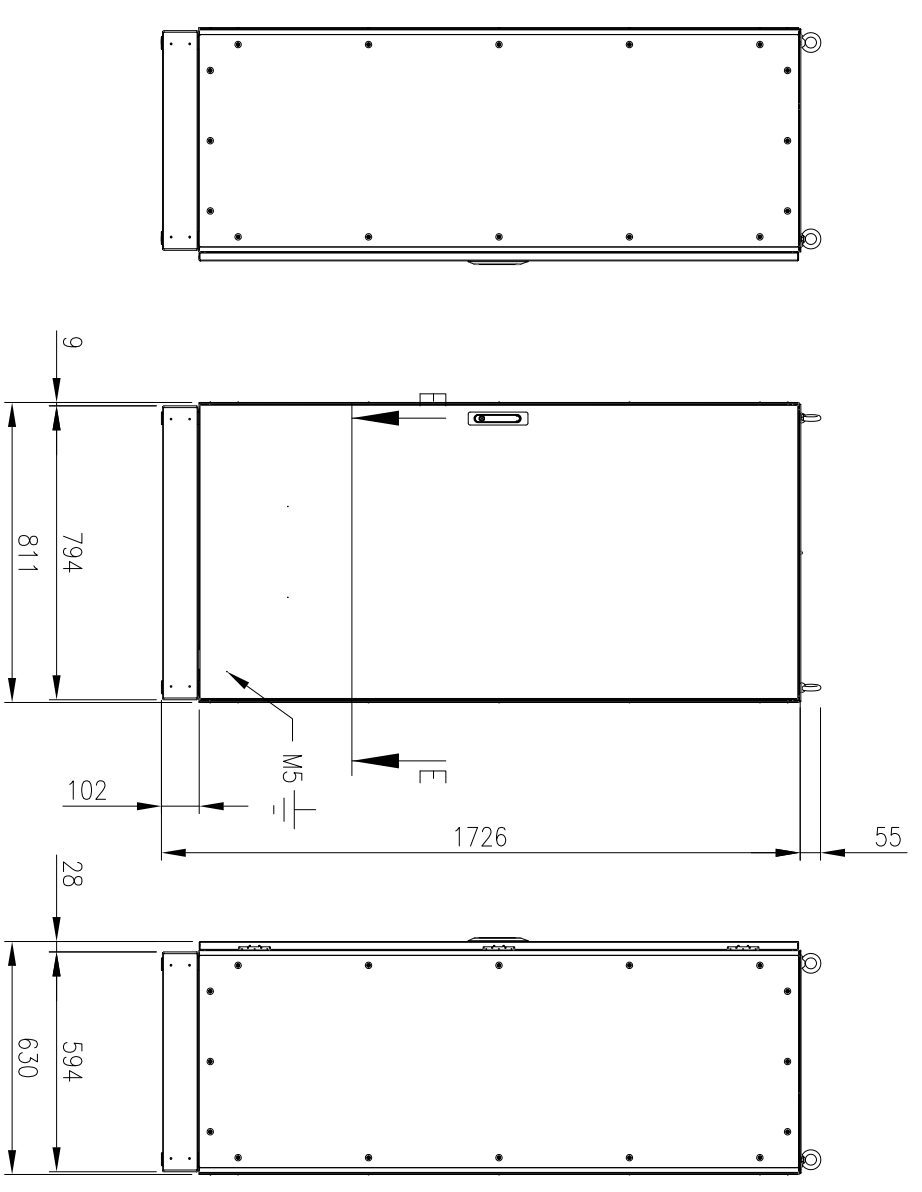
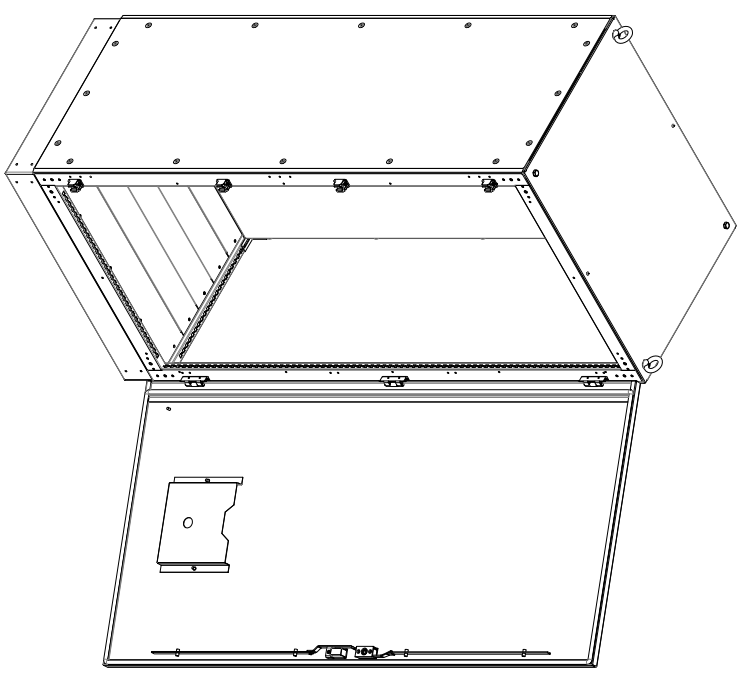

FRONT VIEW
(ASSEMBLY)

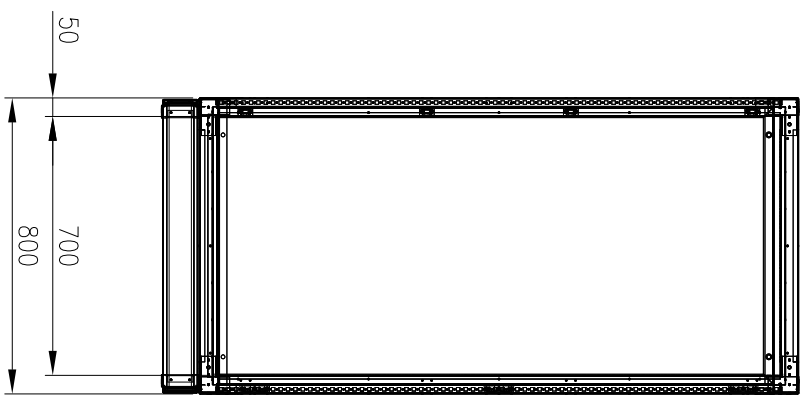

FRONT VIEW
(PANELS REMOVED)

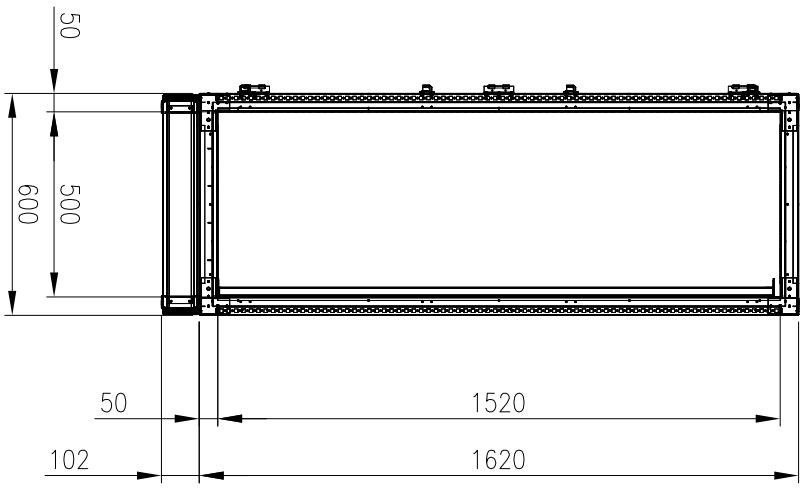

SIDE VIEW
(PANELS REMOVED)

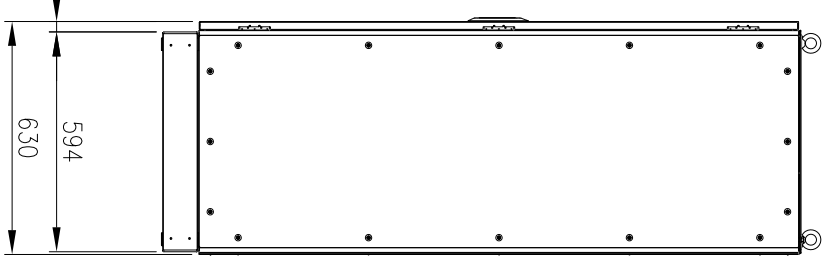

SIDE VIEW

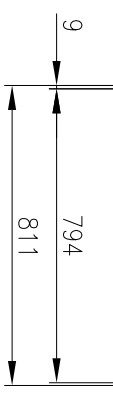

SIDE VIEW

MATERIAL
 MAIN FRAME: 2.0mm GALVANISED STEEL PROFILE
 PANELS: 1.2mm POWDERCOATED GALVANISED SHEET
 DOOR: 2.0mm POWDERCOATED GALVANISED STEEL
 MOUNTING PLATE: 2.0mm GALVANISED STEEL SHEET
 SEAL: EPDM
 SURFACE TREATMENT: POWDER-COAT 80-120micron
 STANDARD COLOUR: RAL7035

PROTECTION: IP55 IK10
 STANDARD: IEC/EN/AS62208, IEC/EN/AS60529

ORDERING INFORMATION:
 - ENCLOSURE: IP-MFS1628060
 - SIDE PANEL: IP-MFSP16260
 - MOUNTING PLATE: IP-MFSM16280
 - BASE: IP-MFSB8060

© IP ENCLOSURES 2017.
 THIS DRAWING SHALL NOT BE COPIED OR REPRODUCED
 WITHOUT AUTHORISATION FROM IP ENCLOSURES.
 www.ipenclosures.com.au

Item#	Quantity	TradeName, designation, material, dimension etc.	Article No./Reference	Scale
IP		Designed by	22/11/17	1:20
IP		Checked by	22/11/17	1/1
		Approved by - date	22/11/17	
		Filename	1620X800X600 STEEL FREESTANDING	
		Date	22/11/17	
		Article No./Reference	IP-MFS1628060	
		Edition	0	
		Sheet	1/1	

