

RevNo	Revision note	Date	Signature	Checked
2	GENERAL REVISION	28/05/25	IP	IP

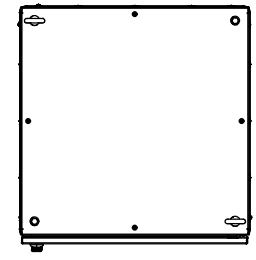

TOP VIEW

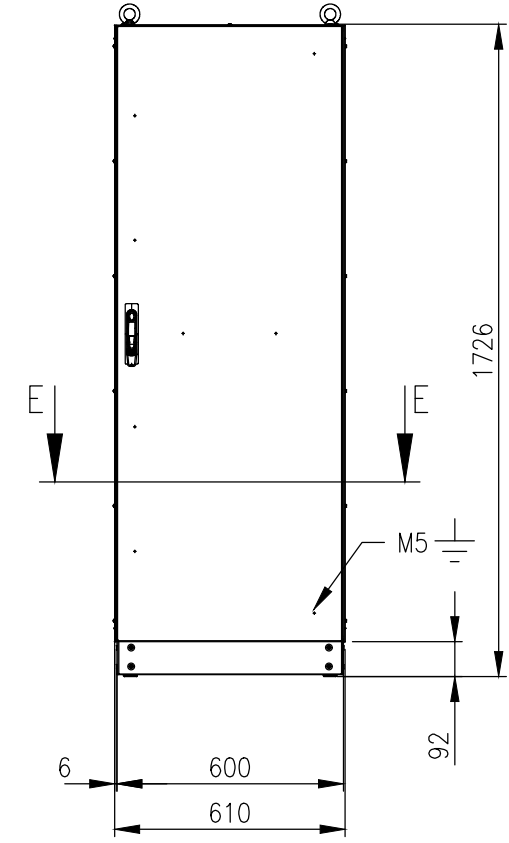

FRONT VIEW (ASSEMBLY)

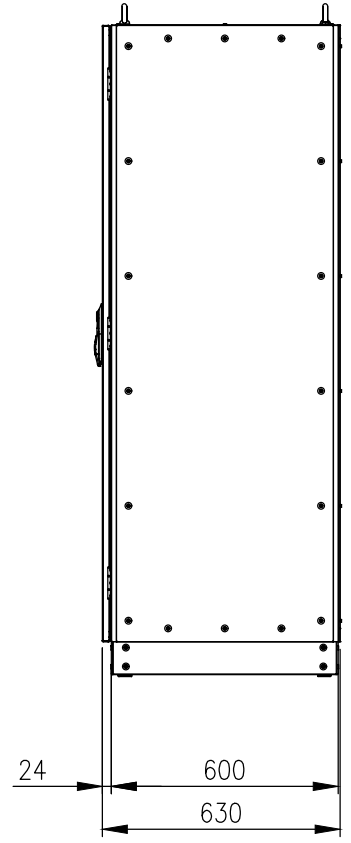

SIDE VIEW

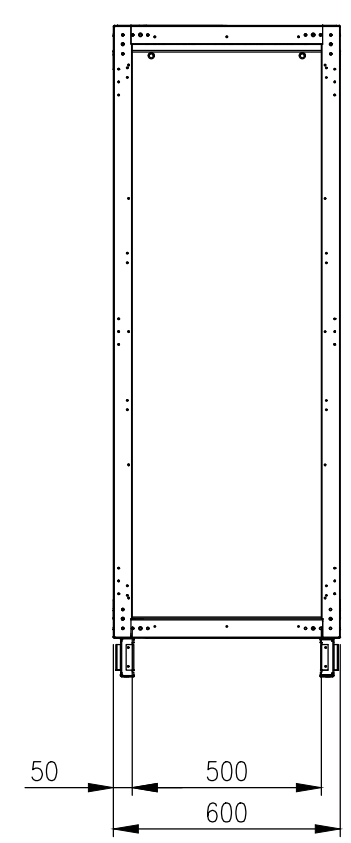

FRONT VIEW (PANELS REMOVED)

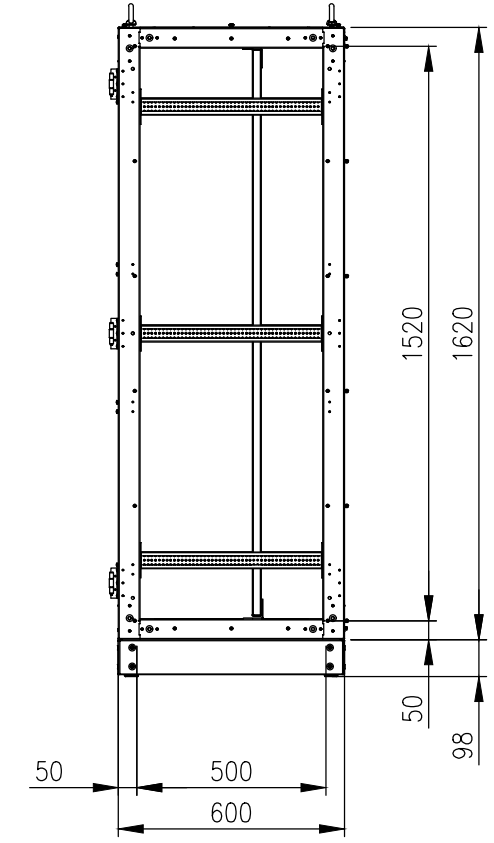

SIDE VIEW (PANELS REMOVED)

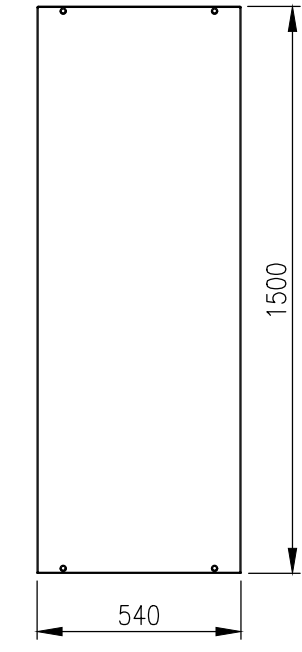

DEVICE MOUNTING PLATE

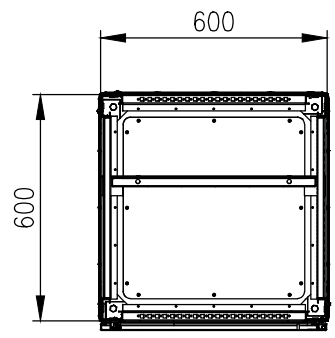
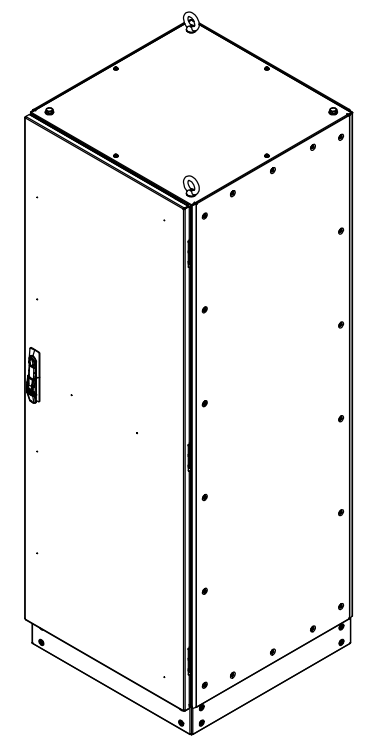

SECTION E-E

MATERIAL
 MAIN FRAME: 2.0mm GALVANISED STEEL PROFILE
 PANELS: 1.2mm POWDERCOATED GALVANISED SHEET
 DOOR: 2.0mm POWDERCOATED GALVANISED STEEL
 MOUNTING PLATE: 2.0mm GALVANISED STEEL SHEET
 SEAL: EPDM
 SURFACE TREATMENT: POWDER-COAT 80-120micron
 STANDARD COLOUR: RAL7035 LIGHT GREY

MASS: 116.0Kg.

PROTECTION: IP55 IK10
 STANDARD: IEC62208, IEC/EN/AS60529
 ORDERING INFORMATION:
 - ENCLOSURE: IP-MFS1626060
 - SIDE PANEL: IP-MFSP16260
 - MOUNTING PLATE: IP-MFSM16260
 - BASE: IP-MFSB6060

© IP ENCLOSURES 2017.
 THIS DRAWING SHALL NOT BE COPIED OR REPRODUCED
 WITHOUT AUTHORISATION FROM IP ENCLOSURES.
 www.ipenclosures.com.au

Itemref	Quantity	Title/Name, designation, material, dimension etc	Article No./Reference
Designed by IP	Checked by IP	Approved by - date 22/11/17	Filename IP-MFS1626060-KIT
		Date 22/11/17	Scale 1:20
			1620x600x600 STEEL FREESTANDING
IP-MFS1626060-KIT			Edition 2
			Sheet 1/1