

RevNo	Revision note	Date	Signature	Checked
1	GENERAL REVISION	9/7/19	IP	IP

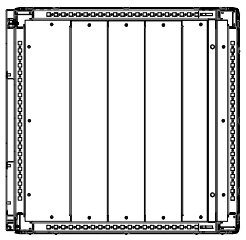

SECTION E-E

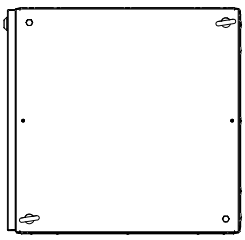

TOP VIEW

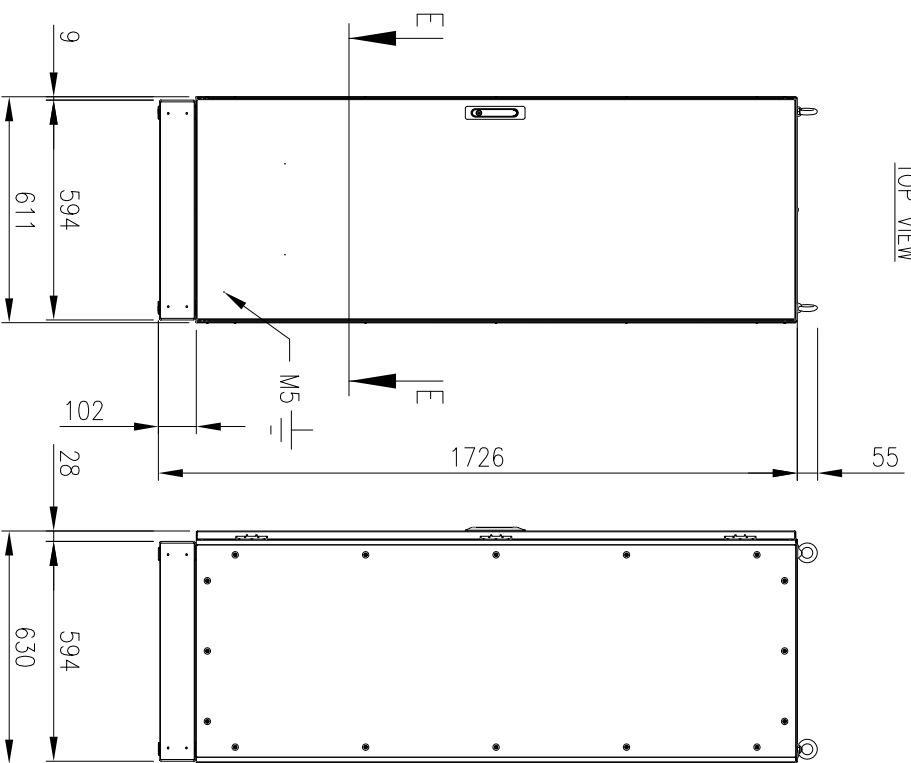

FRONT VIEW
(ASSEMBLY)

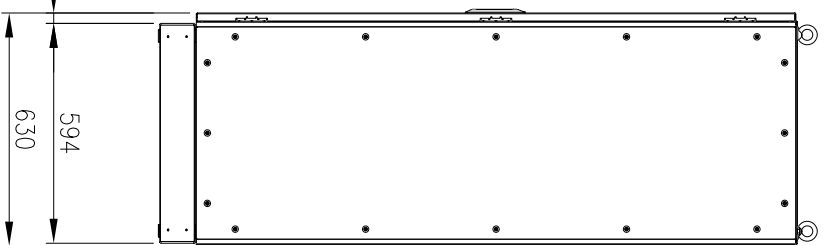

SIDE VIEW

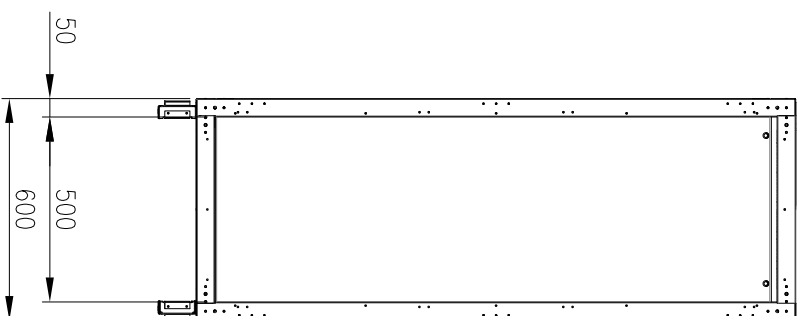

FRONT VIEW
(PANELS REMOVED)

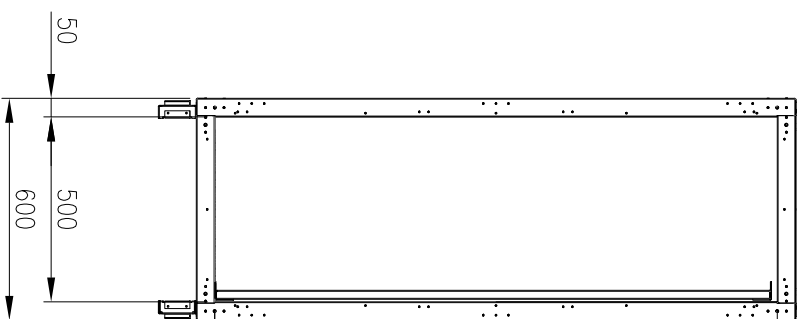

SIDE VIEW
(PANELS REMOVED)

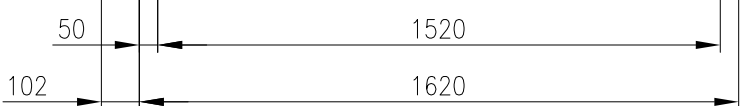

DEVICE MOUNTING PLATE

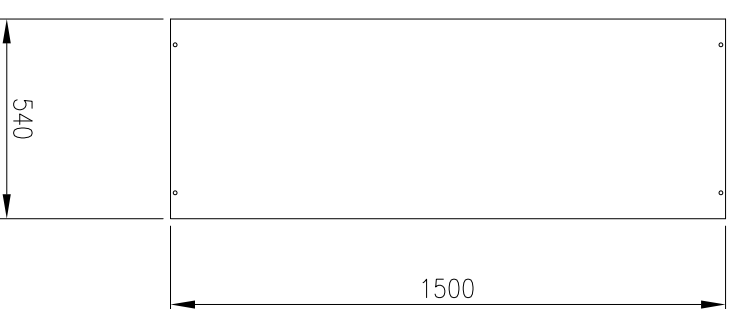

MATERIAL
 MAIN FRAME: 2.0mm GALVANISED STEEL PROFILE
 PANELS: 1.2mm POWDERCOATED GALVANISED SHEET
 DOOR: 2.0mm POWDERCOATED GALVANISED STEEL
 MOUNTING PLATE: 2.0mm GALVANISED STEEL SHEET
 SEAL: EPDM
 SURFACE TREATMENT: POWDER-COAT 80-120micron
 STANDARD COLOUR: RAL7035

PROTECTION: IP55 IK10
 STANDARD: IEC62208, IEC/EN/AS60529

ORDERING INFORMATION:
 - ENCLOSURE: IP-MFS1626060
 - SIDE PANEL: IP-MFSP16260
 - MOUNTING PLATE: IP-MFSM16260
 - BASE: IP-MFSB6060

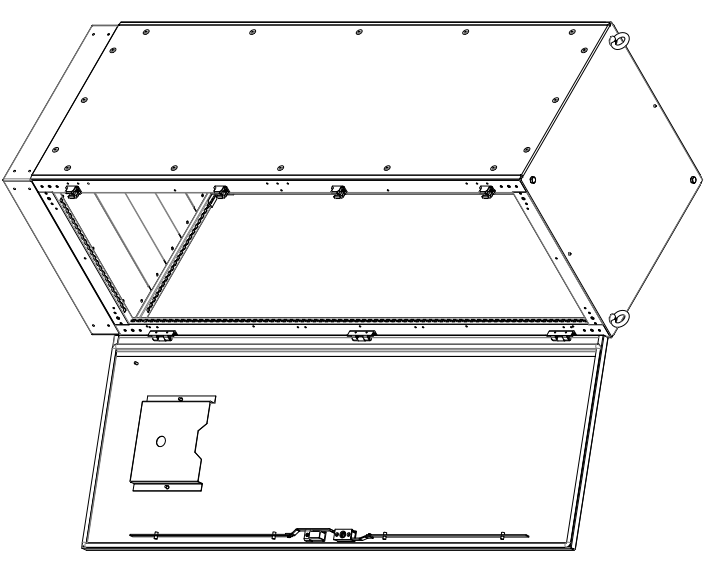

© IP ENCLOSURES 2017.
 THIS DRAWING SHALL NOT BE COPIED OR REPRODUCED
 WITHOUT AUTHORISATION FROM IP ENCLOSURES.
 www.ipenclosures.com.au

Item	Quantity	Part/Name, designation, material, dimension etc.	Article No./Reference	Scale
IP		Designed by		1:20
IP		Checked by		
IP		Approved by - date		
		22/11/17		
		Filename		
		1620x600x600 STEEL FREESTANDING		
		IP-MFS1626060		
		IP-MFS1626060		
		1		
		Sheet		
		1/1		