

RevNo	Revision note	Date	Signature	Checked
0	GENERAL REVISION		IP	IP

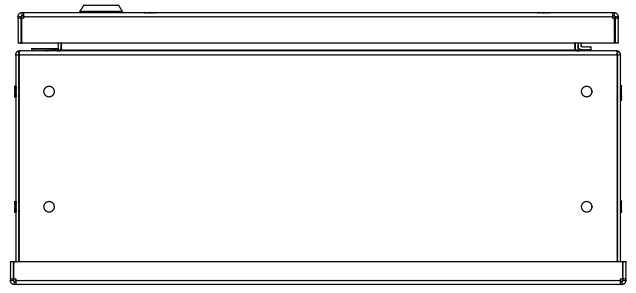

TOP VIEW

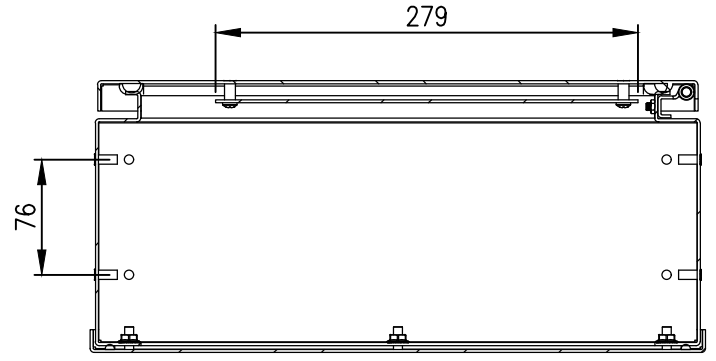

SECTION A-A

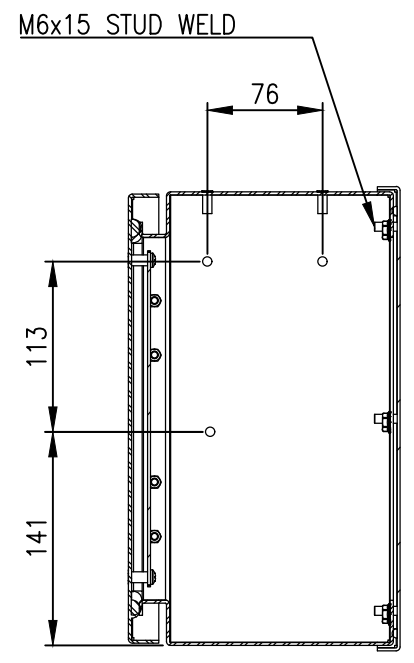

SECTION B-B

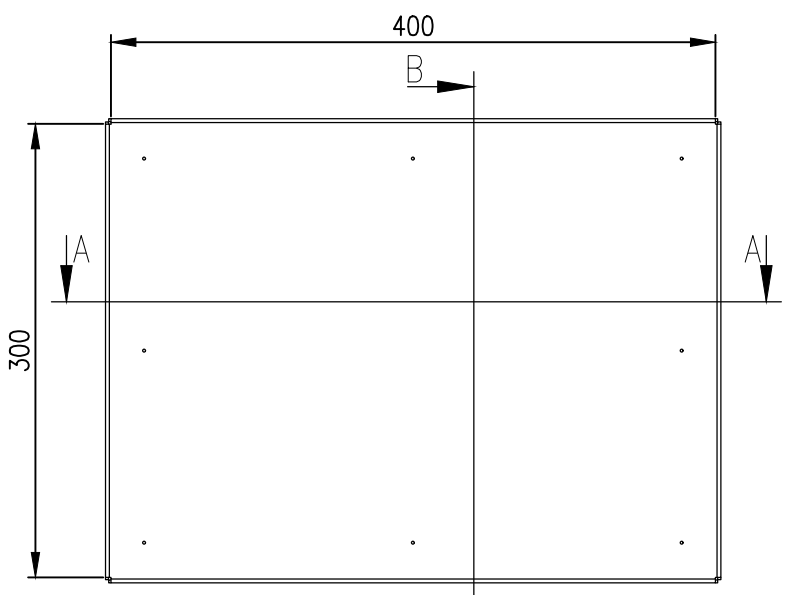

FRONT VIEW

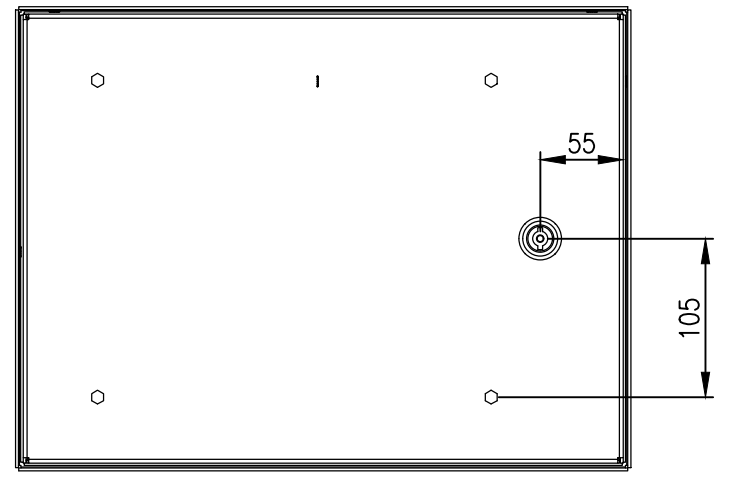

REAR VIEW

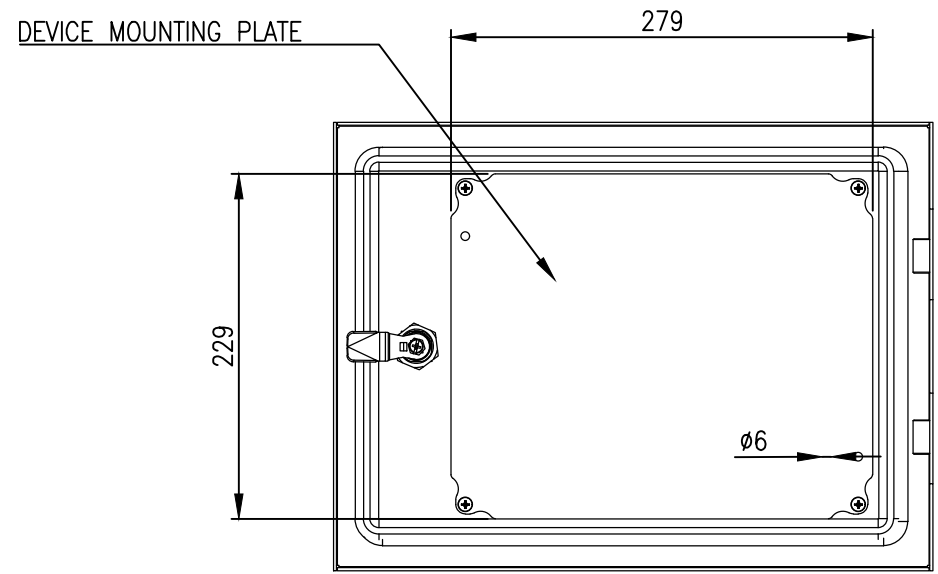
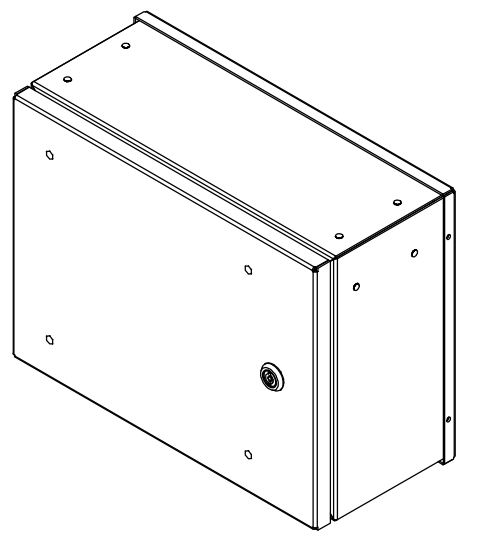

REAR-DOOR INTERIOR VIEW

MATERIAL
ENCLOSURE BODY: 2.0mm GALVANISED STEEL SHEET
ENCLOSURE DOOR: GALVANISED STEEL SHEET
ENCLOSURE FRONT PANEL: GALVANISED STEEL SHEET
ENCLOSURE SEAL: POLYURETHANE
SURFACE TREATMENT: POWDER-COAT 80-120 MICRON
STANDARD COLOUR: RAL7035

PROTECTION: IP66
STANDARD: AS/EN/IEC60529

© IP ENCLOSURES 2022.
THIS DRAWING SHALL NOT BE COPIED OR REPRODUCED WITHOUT
AUTHORISATION FROM IP ENCLOSURES.
www.ipenclosures.com.au

Itemref	Quantity	Title/Name, designation, material, dimension etc	Article No./Reference
Designed by IP	Checked by IP	Approved by - date 09/08/22	Filename IP-HMI304015 Date 09/08/22 Scale 1:5
		300Hx400Wx150D STEEL HMI ENCLOSURE IP-HMI304015 Edition 0 Sheet 1/1	