

RevNo	Revision note	Date	Signature	Checked
1	GENERAL REVISION	23/06/25	IP	IP

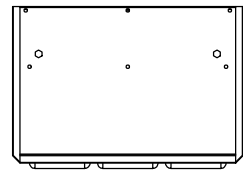

TOP VIEW

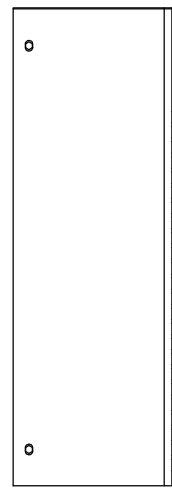

LEFT SIDE VIEW

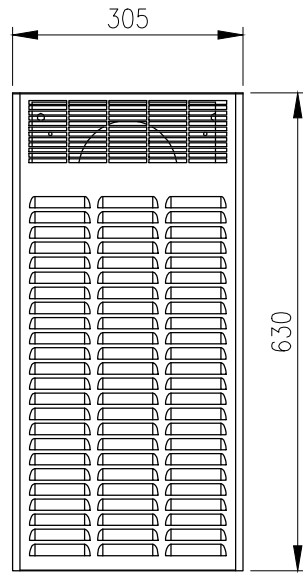

FRONT VIEW

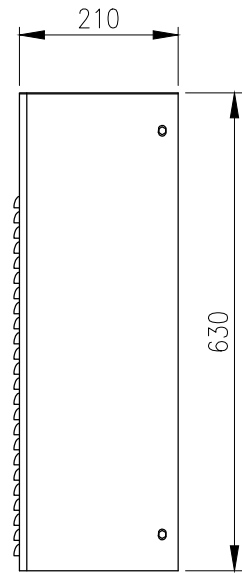

RIGHT SIDE VIEW

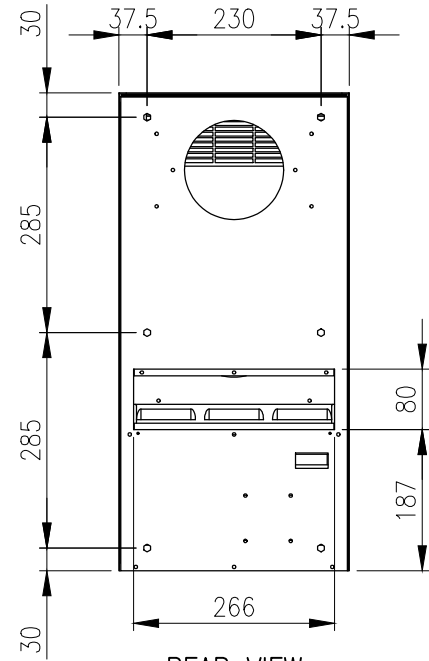

REAR VIEW

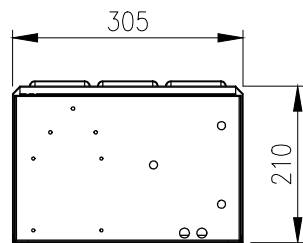
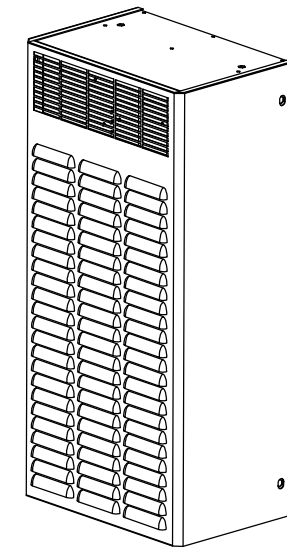

BOTTOM VIEW

MATERIAL

CASING: GALVANISED STEEL SHEET
 COVER: GALVANISED STEEL SHEET
 SURFACE TREATMENT: POWDER-COAT 80-120micron
 COLOUR: RAL7035 LIGHT GREY

MASS(with PACKAGING): 23(24)Kg.

PROTECTION: IP54 (EN60529/1 ENCLOSURE SIDE)
 IP34 (EN60529/1 AMBIENT SIDE)
 STANDARD: SAA, CE, AS/NZS60335.2.40:2019
 AS/NZS60335.1:2020

© IP ENCLOSURES 2024.
 THIS DRAWING SHALL NOT BE COPIED OR REPRODUCED
 WITHOUT AUTHORISATION FROM IP ENCLOSURES.
 www.ipenclosures.com.au

Itemref	Quantity	Title/Name, designation, material, dimension etc	Article No./Reference
Designed by IP	Checked by IP	Approved by - date 20/11/24	Filename IP-ACOWM085.003
		Date 20/11/24	Scale 1:10
			850W OUTDOOR WALL MOUNTED AIR CONDITIONER IP-ACOWM085.003
Edition 1			Sheet 1/1