

RevNo	Revision note	Date	Signature	Checked
0	GENERAL REVISION		IP	IP

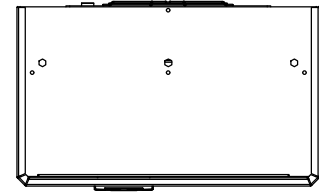

TOP VIEW

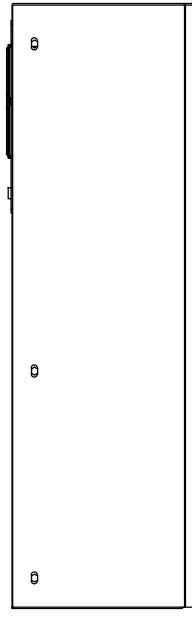

LEFT SIDE VIEW

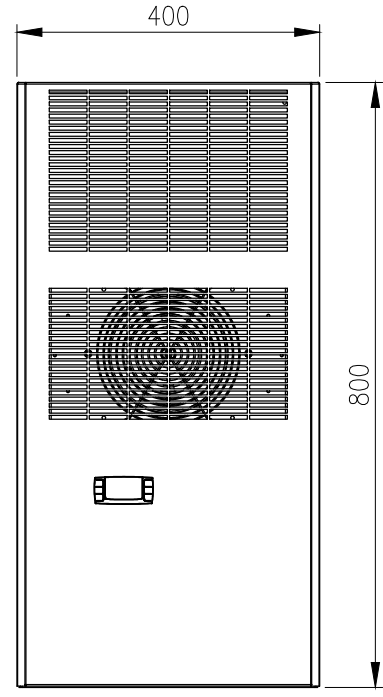

FRONT VIEW

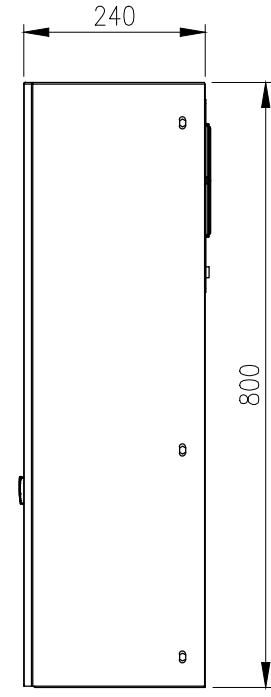

RIGHT SIDE VIEW

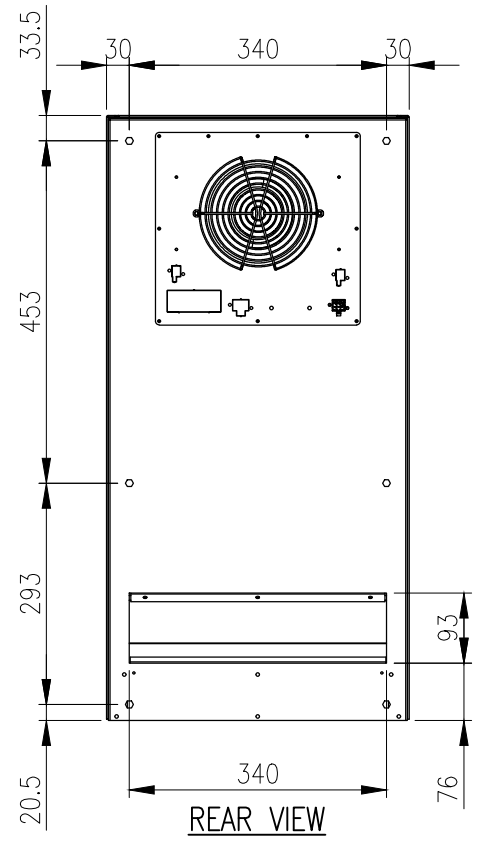

REAR VIEW

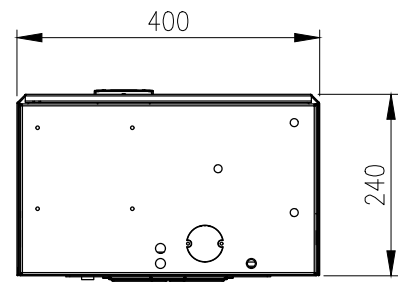
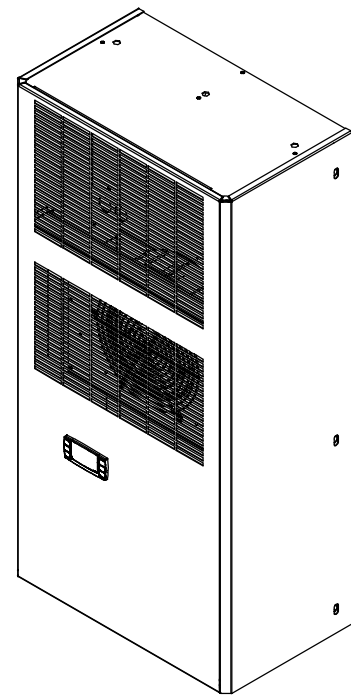

REAR VIEW

MATERIAL
 CASING: GALVANISED STEEL SHEET
 COVER: GALVANISED STEEL SHEET
 SURFACE TREATMENT: POWDER-COAT 80-120micron
 COLOUR: RAL7035 LIGHT GREY

MASS(with PACKAGING): 37(38)Kg.

PROTECTION: IP54 (EN60529/1 ENCLOSURE SIDE)
 IP34 (EN60529/1 AMBIENT SIDE)
 STANDARD: SAA, CE, AS/NZS60335.2.40:2019
 AS/NZS60335.1:2020

© IP ENCLOSURES 2024.
 THIS DRAWING SHALL NOT BE COPIED OR REPRODUCED
 WITHOUT AUTHORISATION FROM IP ENCLOSURES.
 www.ipenclosures.com.au

Itemref	Quantity	Title/Name, designation, material, dimension etc			Article No./Reference	
Designed by	Checked by	Approved by - date	Filename	Date	Scale	
IP	IP	19/11/24	IP-ACIWM145.003	19/11/24	1:10	
			1450W INDOOR WALL MOUNTED AIR CONDITIONER			
			IP-ACIWM145.003		Edition	Sheet
					0	1/1