

RevNo	Revision note	Date	Signature	Checked
0	GENERAL REVISION		IP	IP

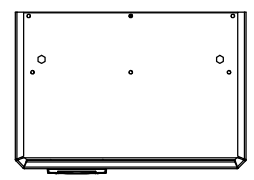

TOP VIEW

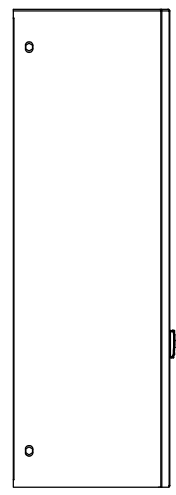

LEFT SIDE VIEW

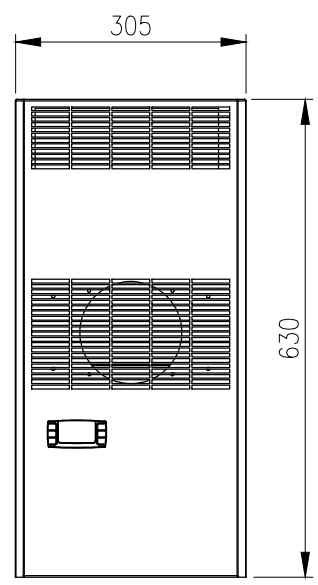

FRONT VIEW

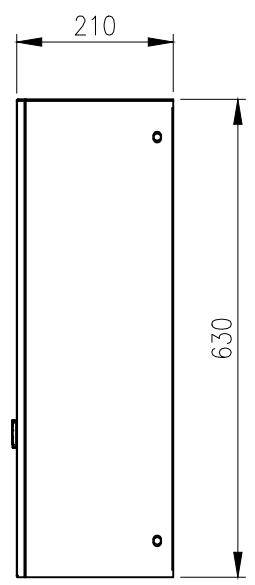

RIGHT SIDE VIEW

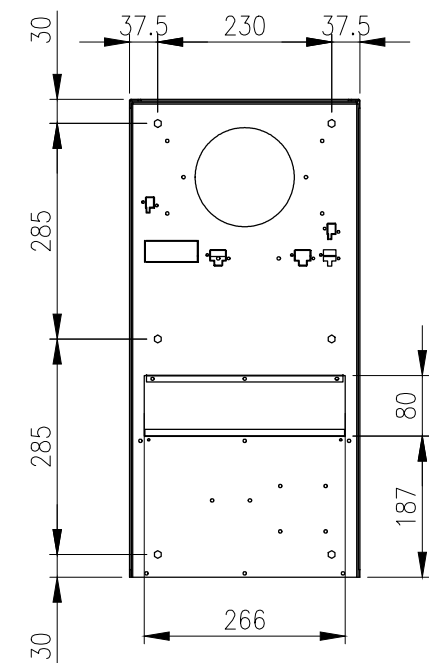

REAR VIEW

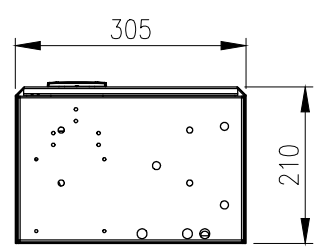
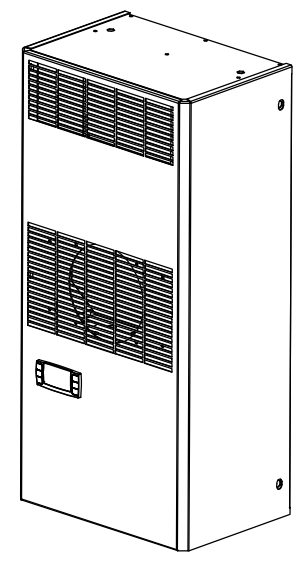

BOTTOM VIEW

**MATERIAL**  
 CASING: GALVANISED STEEL SHEET  
 COVER: GALVANISED STEEL SHEET  
 SURFACE TREATMENT: POWDER-COAT 80-120micron  
 COLOUR: RAL7035 LIGHT GREY

MASS(with PACKAGING): 23(24)Kg.

PROTECTION: IP54 (EN60529/1 ENCLOSURE SIDE)  
 IP34 (EN60529/1 AMBIENT SIDE)  
 STANDARD: SAA, CE, AS/NZS60335.2.40:2019  
 AS/NZS60335.1:2020

© IP ENCLOSURES 2024.  
 THIS DRAWING SHALL NOT BE COPIED OR REPRODUCED  
 WITHOUT AUTHORISATION FROM IP ENCLOSURES.  
 www.ipenclosures.com.au

Itemref	Quantity	Title/Name, designation, material, dimension etc			Article No./Reference	
Designed by IP	Checked by IP	Approved by - date 19/11/24	Filename IP-ACIWM085.003	Date 19/11/24	Scale 1:10	
			850W INDOOR WALL MOUNTED AIR CONDITIONER			
			IP-ACIWM085.003		Edition 0	Sheet 1/1