

A1 Electrical Enclosure

IP-A302015

ALUMINIUM | SINGLE DOOR | IP66

300H x 200W x 150D

The A1 range of aluminium electrical enclosures are fabricated from marine grade aluminium and are rated for protection up to IP66. They are suitable for heavy duty applications.

Protection: IP66 IK10

Standards (& Conformities): IEC/EN 60529, IEC/EN 62208, RoHS

Material:

- Body: 2.5mm marine grade aluminium
- Door: 2.5mm marine grade aluminium
- Device Mounting Plate: 1.5mm galvanised steel sheet
- Seal: Polyurethane



Enclosure Body: The robust monoblock body is fabricated using 2.5mm marine grade aluminium. Flat face sealing surfaces are provided to increase seal life. Integral device plate mounts, M6 earth studs and welded mounting feet are incorporated. Cutting, pressing and full continuous seam welding using precision automated manufacturing equipment ensures accuracy and consistent high quality.

Enclosure Door: The robust surface mounted door is fabricated using 2.5mm marine grade aluminium and incorporates concealed removable hinges with captive pins. The door is designed for a 110° opening. Each door contains an M6 earth stud and a high quality machine-applied foamed in place (FIP) Polyurethane seal.

Enclosure Seal: A high quality machine-applied full perimeter UL listed Polyurethane seal foamed in place (FIP) provides excellent sealing over a long life. Temperature resistance -40°C to 80°C (160°C short term loading).

Enclosure Lock: Stainless steel 8mm square drive quarter turn lock with key.

Device Mounting Plate: The device mounting plate is 1.5mm galvanised steel sheet. It is pressed to provide strength and is pre-fitted into the enclosure as standard.

Surface Treatment: UL approved AkzoNobel epoxy polyester powder-coated with a textured finish. 80-120 micron average thickness. Colour RAL7035.

Mass: 4Kg.

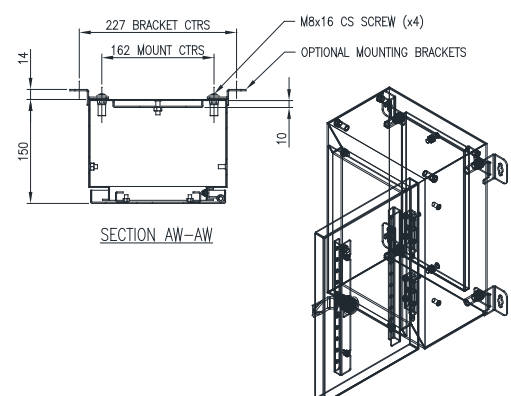
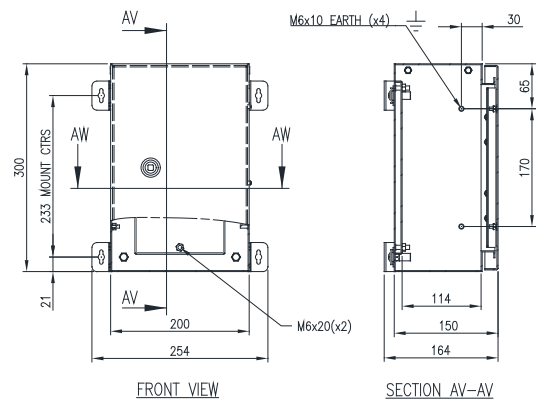

A1 Electrical Enclosure

IP-A302015

ALUMINIUM | SINGLE DOOR | IP66

300H x 200W x 150D

ACCESSORIES:

Part Number	Description
IP-DINRAIL 7.5X35-130	DIN Rail x 130mm (Pack of 10)
IP-EK01	Standard Earthing Kit
IP-WMBKIT	Wall-Mounting Bracket Kit (with 4x Brackets and Fasteners)
IP-PMP200	U-Channel Profile 200mm Long; Powder-Coated
IP-PMB	Pole Mount Bracket to Suit Large Diameter Poles (Use with Bandit Strap)

CERTIFICATES:

IEC 60529 Degrees of protection provided by enclosures: Certificate AB-1374-T 2021-PTC-1162-2
IEC/EN 62208 Empty Enclosures for low-voltage switchgear and controlgear assemblies: Certificate 0366932-TSE-01/01
CE Certificate of Compliance: Certificate SZL-21 MA 13338-1
UKCA Certificate of Compliance: Certificate SZU-22 MA 19560-1
UL: Listing Number E534557

Products are manufactured to Quality, Safety and Environmental Standards.

WARRANTY: 5 years.