

TOP VIEW

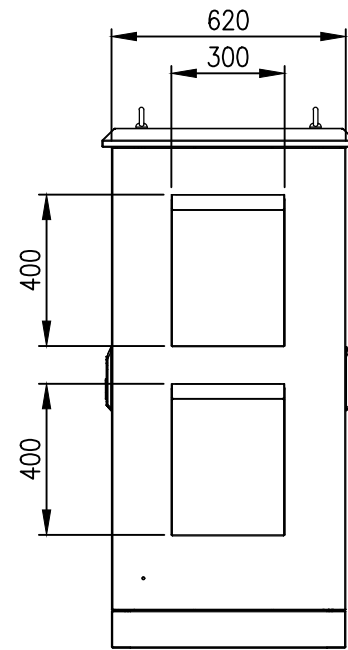

LEFT SIDE VIEW

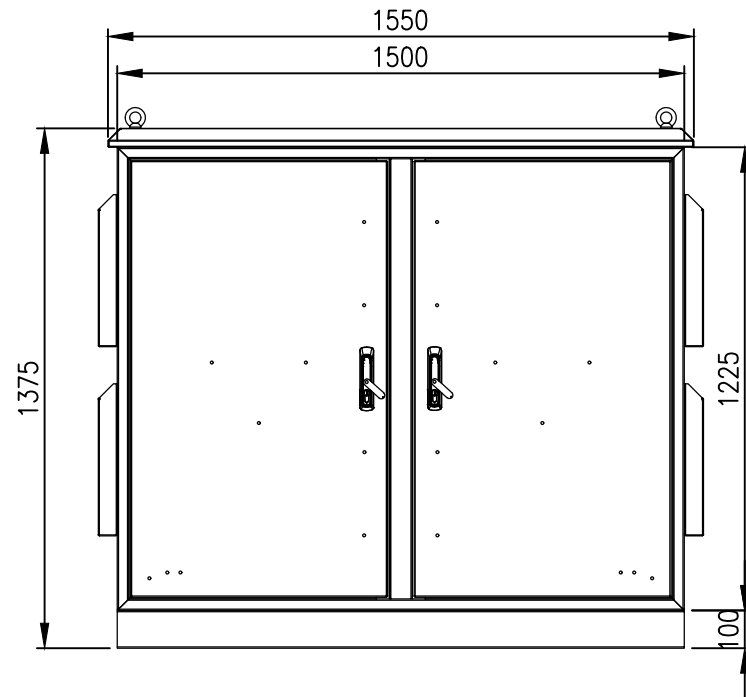

FRONT VIEW

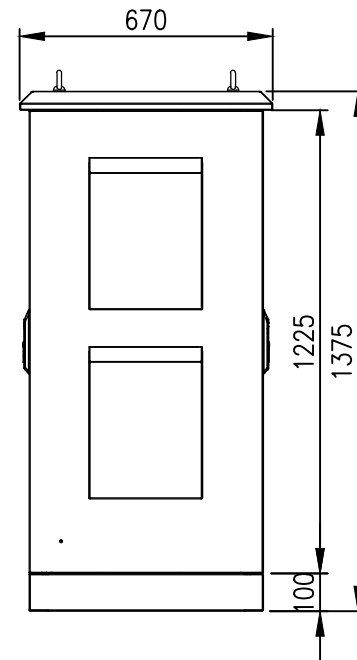

RIGHT SIDE VIEW

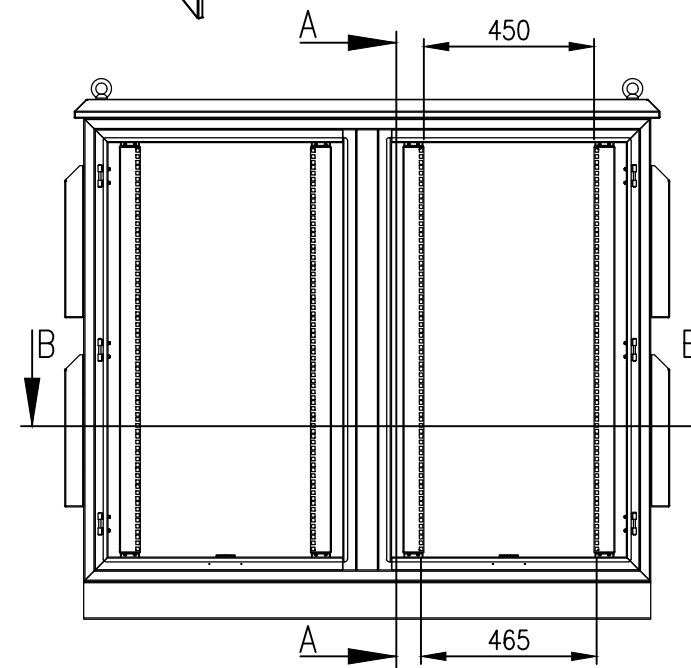

INTERIOR VIEW-DOOR REMOVED

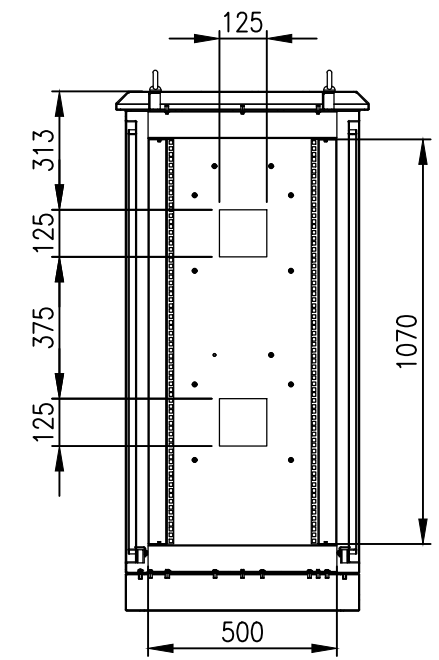

SECTION A-A

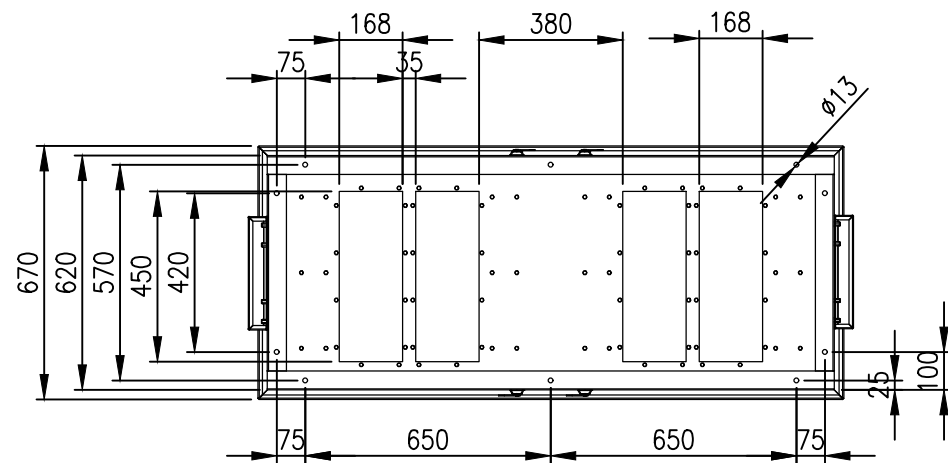

BOTTOM VIEW

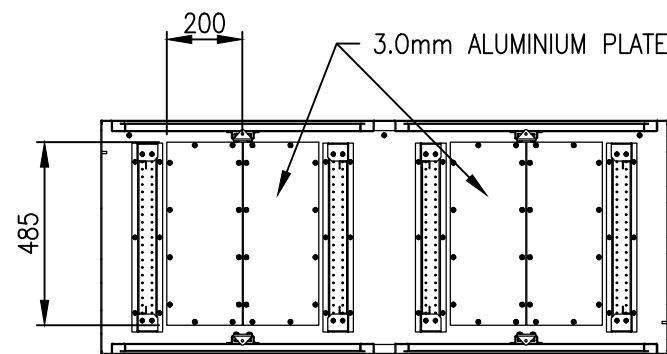

SECTION B-B

**MATERIAL**

BODY AND PLINTH: 2.5mm MARINE GRADE ALUMINIUM 5754-H111  
 DOORS: 2.5mm MARINE GRADE ALUMINIUM 5754-H111  
 19" DATA RAILS: 1.5mm GALVANISED STEEL SHEET  
 GLAND PLATE: 3.0mm ALUMINIUM  
 SEAL: POLYURETHANE  
 SURFACE TREATMENT: POWDER-COAT 80-120micron  
 COLOUR: T33 SMOKE BLUE, SMOOTH FINISH

PROTECTION: IP55

STANDARD: IEC62208, IEC/EN/AS60529, EIA-310D

© IP ENCLOSURES 2024.  
 THIS DRAWING SHALL NOT BE COPIED OR REPRODUCED  
 WITHOUT AUTHORISATION FROM IP ENCLOSURES.  
 www.ipenclosures.com.au

Itemref	Quantity	Title/Name, designation, material, dimension etc	Article No./Reference	
Designed by IP	Checked by IP	Approved by - date 12/01/24	Filename IP-A13715062-T33	Date 12/01/24
Scale 1:20				
			2 x 24RU (48RU) ALUMINIUM FIELD CABINET 1375Hx1500Wx620D DOUBLE BAY IP-A13715062-T33	
Edition 0			Sheet 1/1	