

SST TERMINAL BOX

IP-304-T202010

304 STAINLESS STEEL | IP66, IP67

200H x 200W x 100D

The IP Enclosures SST Range of grade 304 stainless steel terminal boxes are designed for use in the most demanding industrial environments.

Protection: Complies with IP66, IP67, NEMA 4x

Standard:    N° file E534557

Material:

- Body: 1.0mm. AISI 304 (Wnr 1.4301) Scotch-brite
- Door: 1.0mm. AISI 304 (Wnr 1.4301) Scotch-brite
- Seal: Silicone

Surface Finish:

- 0.2 micron Ra surface Scotch-brite finish.

Body: The robust body is fabricated using 1.0mm AISI 304 (Wnr 1.4301) Stainless Steel, scotched-brite finish and incorporates a high quality Silicone seal.

Lid/Door: The robust pre-drilled detachable blind lid/door is fabricated using 1.0mm AISI 304 (Wnr 1.4301) Stainless Steel, scotched-brite finish. The door closing system is done through fastening of M5 screws. The rear part of the door is fastened using M5 bushes.

Seal: Silicone.

Internal Plate: The inner plate is fabricated using 2.5mm FeZn material, supplied pre-fitted into the terminal box as standard.

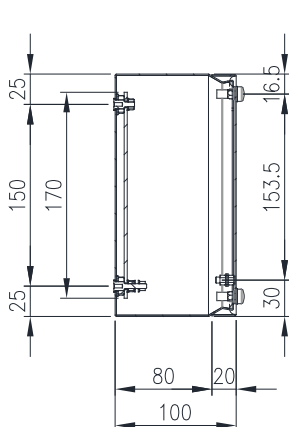
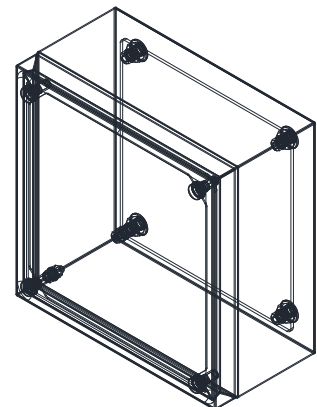

SECTION B-B

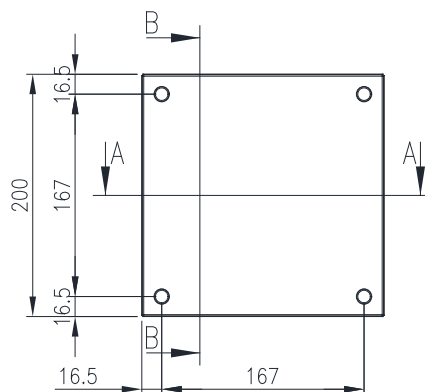

FRONT VIEW

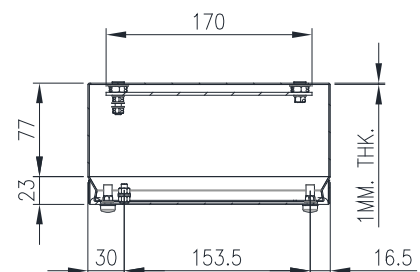

SECTION A-A