

FC 19" Field Cabinet

IP-1677580-T33

**STEEL | SINGLE BAY 19" RACK | VENTILATED
IP55 IK10**

**1675H x 750W x 800D
19" 30RU**

Field Cabinets are designed to house sensitive data network and electrical equipment for a variety of heavy duty outdoor applications including road/traffic management and intelligent transport systems.

Protection: IP55 IK10

Standards (& Conformities): IEC/EN 60529, IEC/EN 62208, EIA-310-D, RoHS



Rack Unit Size: 30RU

Material:

- Body and Plinth: 2.0mm galvanised steel sheet
- Doors: 2.0mm galvanised steel sheet
- 19" Data Rack Rails: 1.5mm galvanised steel sheet
- Gland Plate: 3.0mm aluminium
- Seal: Polyurethane

Body: The robust monoblock body is fabricated using 2.0mm galvanised steel sheet. The body is fitted with rain hood/sunshield, plinth, vent hoods and 4x lifting eye bolts. Flat face sealing surfaces are provided to increase seal life. A 3.0mm aluminium split gland plate is also incorporated into the bottom face. Four cutouts 125mm x 125mm are provided to house fans and filters and each are covered with removable vent hoods. Precision automated manufacturing equipment ensures accuracy and consistent high quality. Fans and filters are ordered separately.

Doors: The front and rear doors are fabricated using 2.0mm galvanised steel sheet and are designed to provide flush recessed mounting to prevent vandalism and unauthorised access. The doors incorporate concealed removable hinges with captive pins. They are designed for a 110° opening and are provided with heavy duty door stays.

19" Data Rack Rails: Front and rear 19" data rack rails are fabricated from 1.5mm galvanised steel sheet.

Seals: A high quality Polyurethane foamed in place (FIP) full perimeter door seals provide excellent sealing over a long life. Temperature resistance -40°C to 80°C.

Locks: Each door includes a 3 point locking system with key-lock swing handle. Optional locking including half euro keyed as required, restricted keys, Bilock and stainless steel padlockable.

Gland Plate: 3.0mm aluminium split gland plates are incorporated into the bottom of the enclosure for cable management.

Surface Treatment: UL approved AkzoNobel polyester powder coated with a smooth gloss finish, 80-120 micron average thickness, providing excellent exterior durability and colour retention. Colour T33 Smoke Blue.

Mass: 157.5Kg.

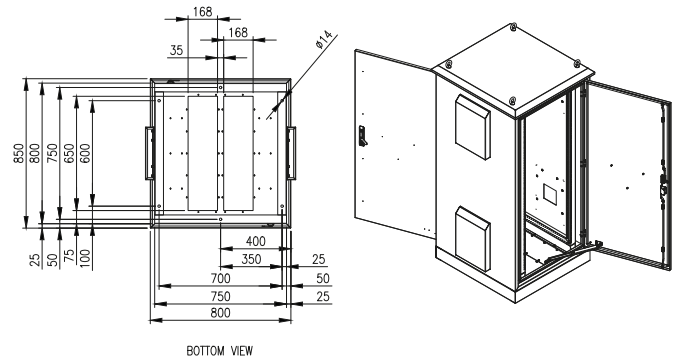
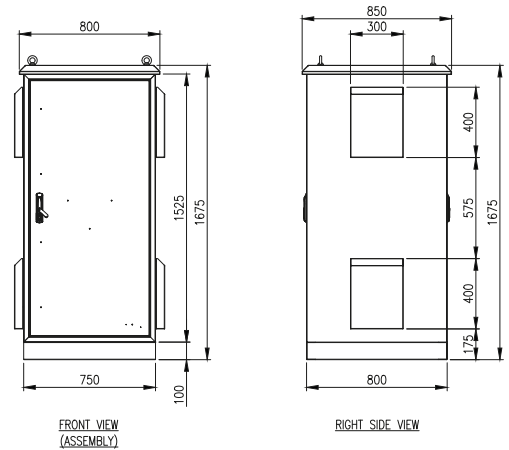

FC 19" Field Cabinet

IP-1677580-T33

STEEL | SINGLE BAY 19" RACK | VENTILATED
IP55 IK10

1675H x 750W x 800D
19" 30RU

ACCESSORIES:

Part Number	Description
IP-FCSHH7580	Heavy Duty Shelf to suit 750W x 800D Field Cabinet; 250Kg.
IP-FCDRAWER800	Laptop Drawer to suit 750W x 800D Field Cabinet; 25Kg.
IP-M6SCREW-CAGENUT	M6 Cage Nut & Screw (Pack of 50)
IP-FCSR7580-T33	Steel Solar Roof to suit 750W x 800D Field Cabinet
IP-L014	3 Point Swing Handle Padlockable; Polyamide & Cast Alloy Coated Black
IP-L076	3 Point Swing Handle Padlockable; Cast Alloy Coated Black

CERTIFICATES:

IEC 60529 Degrees of protection provided by enclosures: Certificate AB-0386-T 2009.33.02/00

IEC/EN 62208 Empty Enclosures for low-voltage switchgear and controlgear assemblies: Certificate 0366932-TSE-01/01

CE Certificate of Compliance: Certificate SZL-21 MA 13338-1

UKCA Certificate of Compliance: Certificate SZU-22 MA 19560-1

Products are manufactured to Quality, Safety and Environmental Standards.

WARRANTY: 5 years.