

S2 Electrical Enclosure

IP-12010040

STEEL | DOUBLE DOOR | IP55

1200H x 1000W x 400D

IP Enclosures S2 Range of steel electrical enclosures are suitable for general industrial applications.

Protection: Complies with IP55 IK10, NEMA 4.
(Independent accredited test laboratory)

Standard: IEC/EN/AS62208, IEC/EN/AS60529, (IEC/EN/AS61439 Compliant, Optional UL508A) **CE**

Material:

- Body: 1.5mm galvanised steel sheet
- Gland Plate: 1.5mm galvanised steel sheet
- Door: 1.5mm galvanised steel sheet
- Device Mounting Plate: 1.5mm galvanised steel sheet
- Seal: Polyurethane

Body: The robust monoblock body is fabricated using 1.5mm galvanised steel sheet. Flat face sealing surfaces are provided to increase seal life. Pre-fitted blind nutserts are incorporated to accommodate mounts and accessory fasteners to eliminate drilling and retain IP rating. Integral device plate mounts and M6 earth stud is provided.

Double Doors: The robust surface mounted doors are fabricated using 1.5mm galvanised steel sheet and incorporates concealed removable hinges with captive pins. The doors are designed to eliminate the central mullion to improve accessibility into the enclosure. The doors are designed for a 110° opening. Each door contains integral cable management rail studs, M6 earth stud.

Seal: A high quality machine-applied continuous foamed in place (FIP) Polyurethane seal provides excellent sealing over a long life.

Lock: 3 point locking system with key-lock swing handle.

Device Mounting Plate: The device mounting plate is fabricated using 1.5mm galvanised steel sheet, pressed to provide additional strength and supplied pre-fitted into enclosure as standard.

Gland Plate: Gland plates are provided with gaskets and fasteners.

Surface Treatment: UL approved epoxy polyester powder-coated with a textured finish. 80-120 micron average thickness. Colour RAL7035 (Other colours available upon request)

Mass: 67.0kg

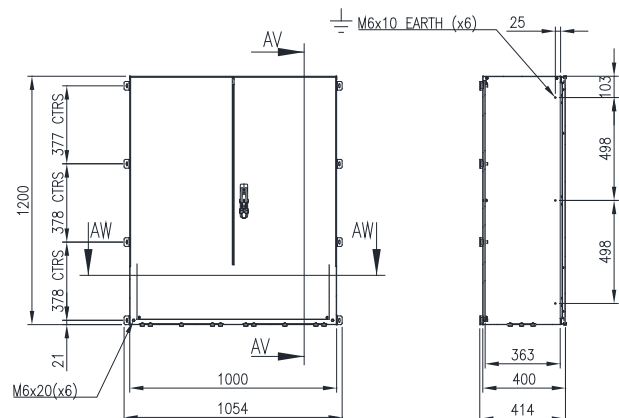

FRONT VIEW

SECTION AV-AV

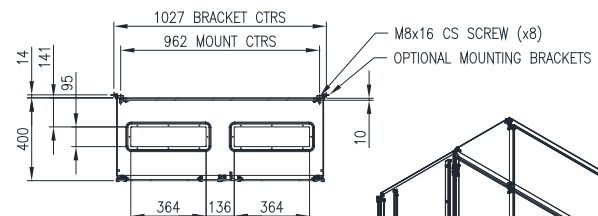

SECTION AW-AW

