

RevNo	Revision note	Date	Signature	Checked
1	GENERAL REVISION	9/8/17	IP	IP

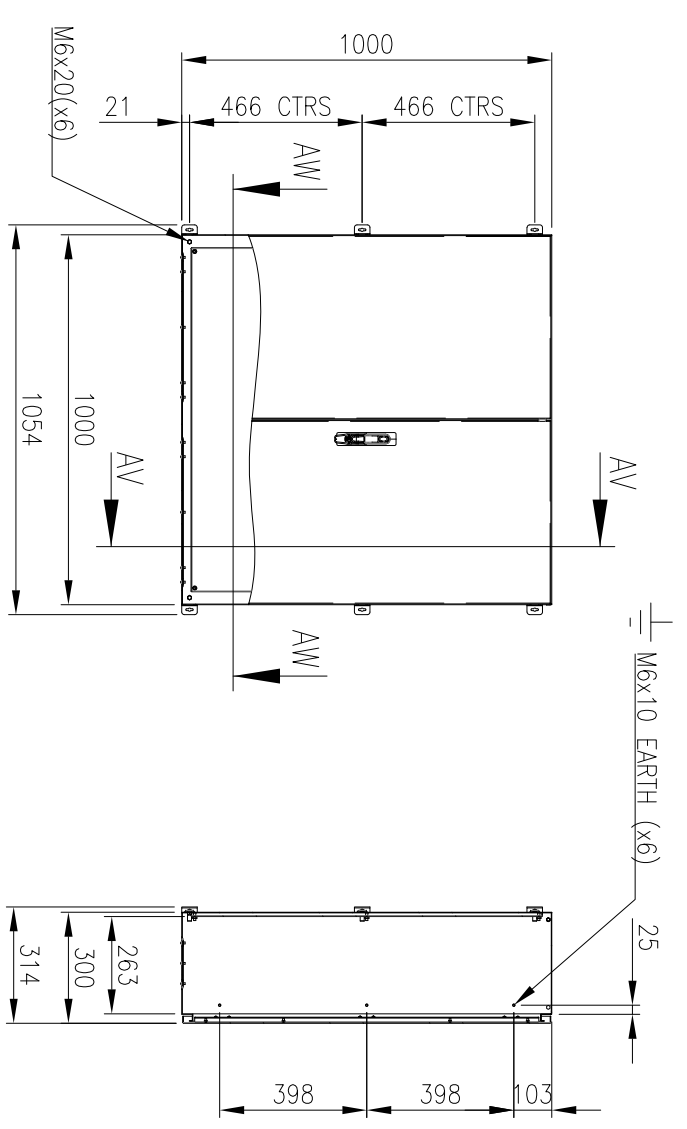

FRONT VIEW

SECTION AV-AV

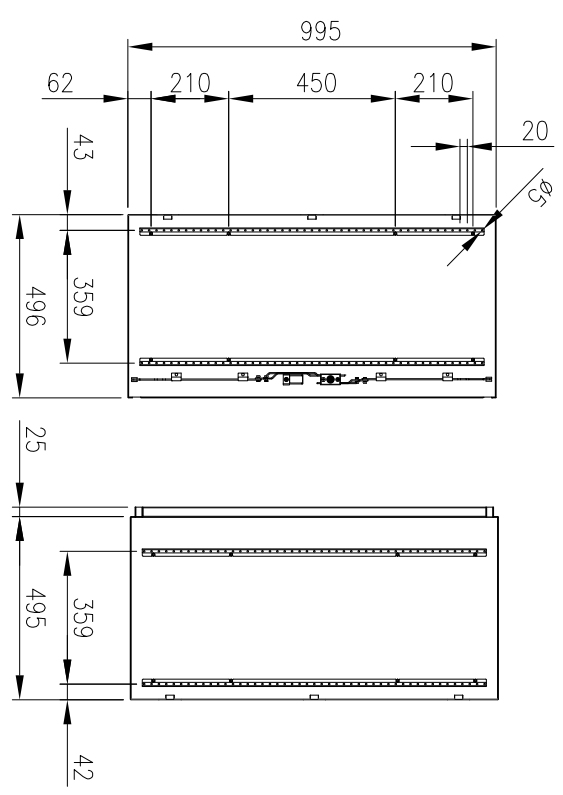

INSIDE DOOR VIEW

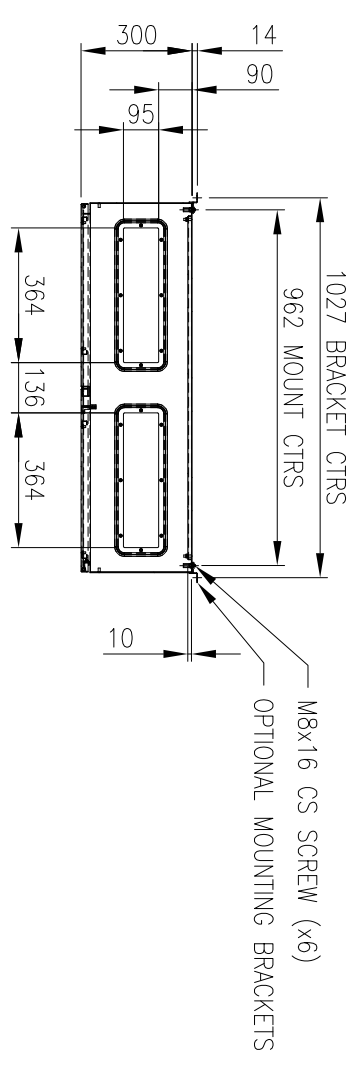
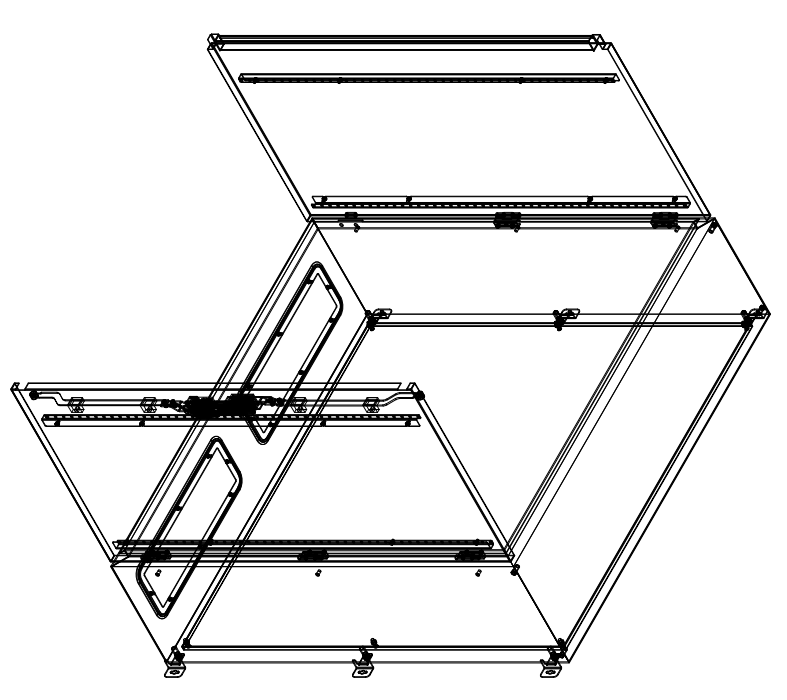

SECTION AW-AW

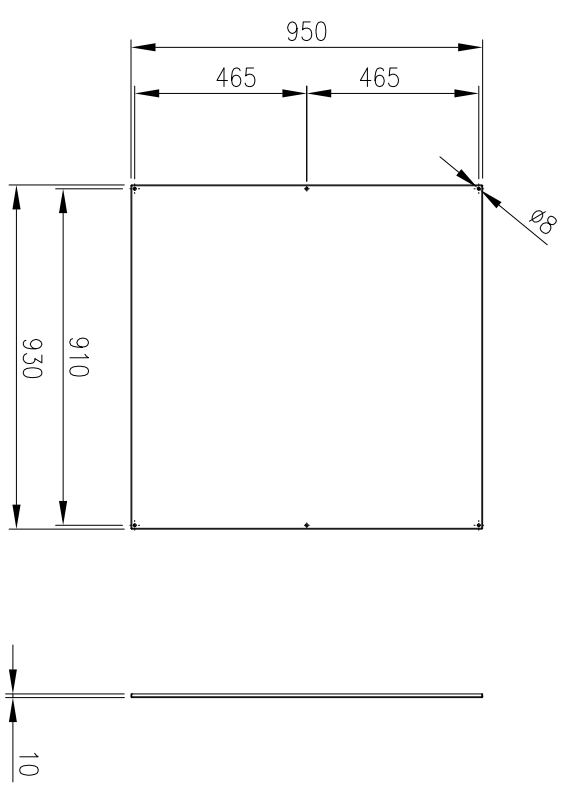

DEVICE MOUNTING PLATE

MATERIAL
 BODY: 1.5mm GALVANISED STEEL SHEET
 DOOR: 1.5mm GALVANISED STEEL SHEET
 DEVICE PLATE: 1.5mm GALVANISED STEEL SHEET
 SEAL: POLYURETHANE
 SURFACE TREATMENT: POWDER-COAT 80-120micron
 MASS: 51.0kg

PROTECTION: IP55 IK10, NEMA4
 STANDARD: IEC/EN/AS62208, IEC/EN/AS60529

© IP ENCLOSURES 2016.
 THIS DRAWING SHALL NOT BE COPIED OR REPRODUCED
 WITHOUT AUTHORISATION FROM IP ENCLOSURES.
 www.ipenclosures.com.au

Item#	Quantity	TradeName, designation, material, dimension etc.	Article No./Reference
IP	1	1000x1000x300 STEEL ENCLOSURE	IP-10010030-01

